



MINECRAFT

21178



Q LEGO® Builder



Get excited about our new packaging!

We're switching from plastic to paper-based packaging. That's why you might find a mix of paper and plastic in our boxes!

Nos nouveaux emballages vous emballeront !

Nous passons des emballages en plastique aux emballages à base de papier. C'est pourquoi vous pourriez trouver un mélange de papier et de plastique dans nos boîtes !

¡Te presentamos nuestros nuevos empaques!

Estamos sustituyendo las bolsas de plástico por bolsas con base de papel. ¡Por eso, puedes encontrar una mezcla de papel y de plástico en nuestras cajas!

[LEGO.com/sustainable-packaging](https://www.lego.com/sustainable-packaging)

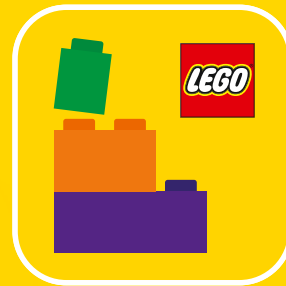

BUILDER



Apple and the Apple logo are trademarks of Apple Inc., registered in the U.S. and other countries and regions. App Store is a service mark of Apple Inc. Google Play and the Google Play logo are trademarks of Google LLC. Tencent and the Tencent logo are trademarks of Tencent Inc.

[LEGO.com/devicecheck](https://www.lego.com/devicecheck)

EN Ask parents' permission before going online | **DE** Eltern um Erlaubnis bitten, bevor du online gehst | **FR** Demande l'autorisation d'un parent avant d'aller en ligne | **IT** Chiedi il permesso ai tuoi genitori prima di andare online | **ES** Pídeles permiso a tus papás antes de conectarte a Internet | **PT** Pede autorização aos pais antes de acederes online | **ZH** 上网前应先征得父母的同意 | **PL** Poproś rodziców o zgodę, zanim wejdiesz do Internetu | **CS** Než půjdeš na internet, požádej rodiče o svolení | **SK** Skôr než pôjdeš na internet, vypýtaj si povolenie od rodičov | **HU** Kérj szülői engedélyt, mielőtt online csatlakoznál! | **RO** Cere permisiunea părinților înainte de a te conecta online | **BG** Поискайте разрешение от родител, преди да влезете онлайн | **LV** Pirms došanās tiešsaistē palūdz atļauju vecākiem | **ET** Enne Interneti kasutamist küsi vanematelt luba | **LT** Prieš prisijungdami prie interneto, atsklauskite tėvų



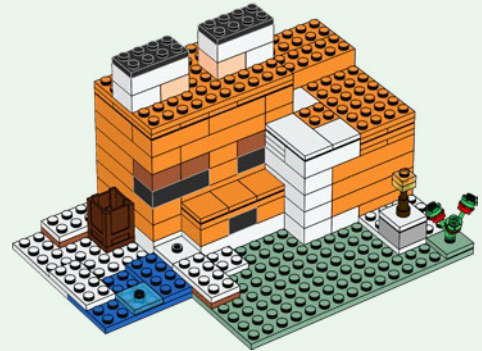
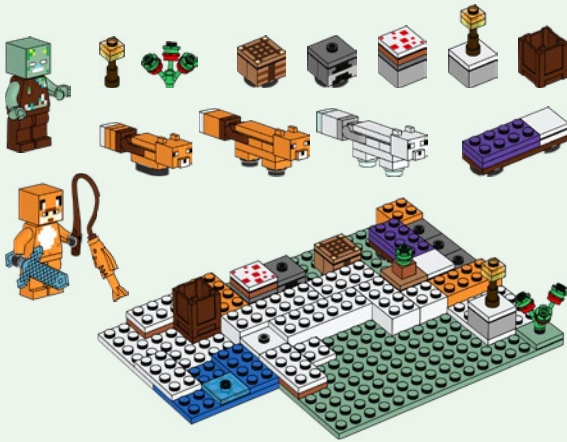

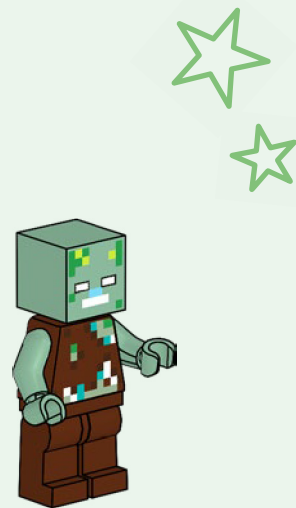
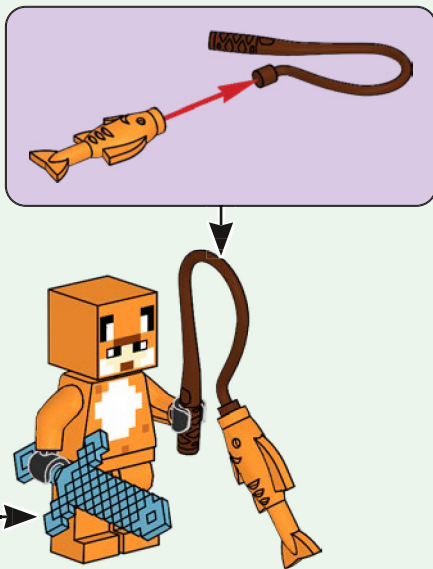
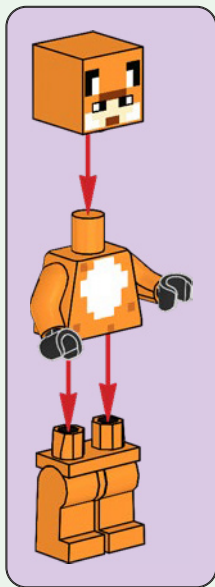
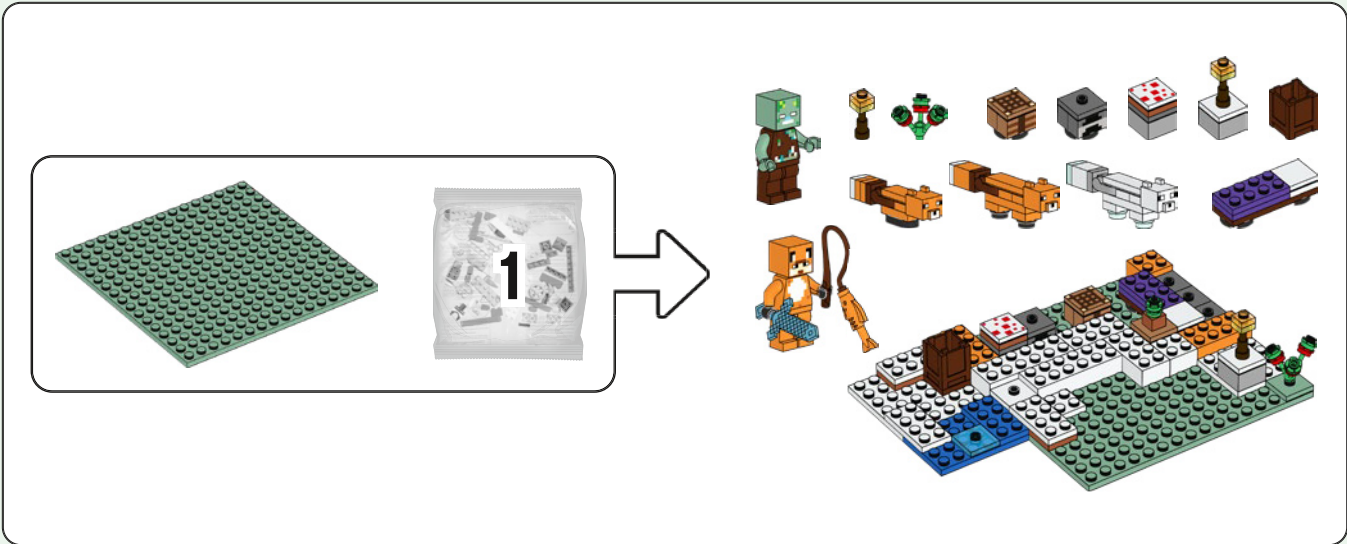

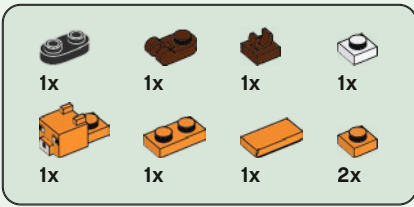

1



2

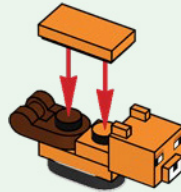

3

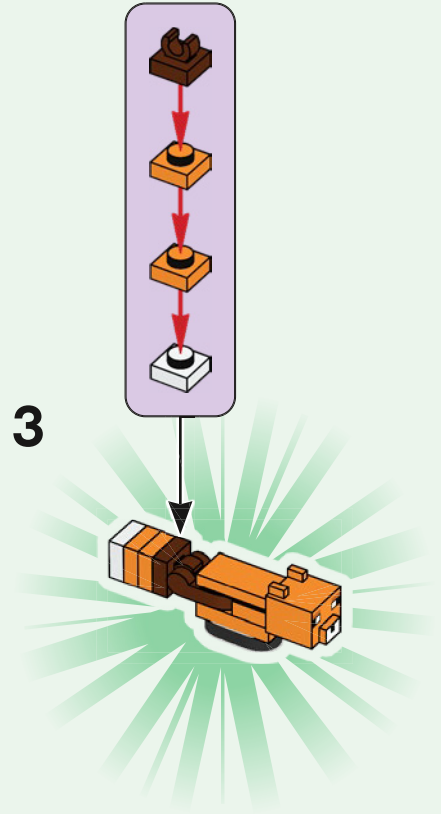

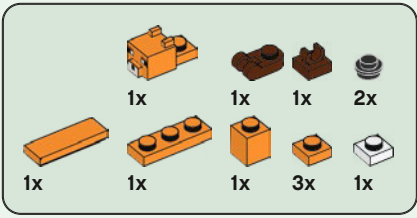

1



2

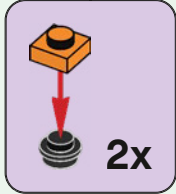

3

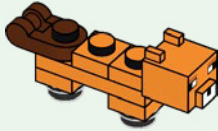

4

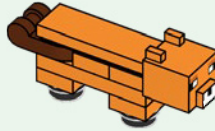

5

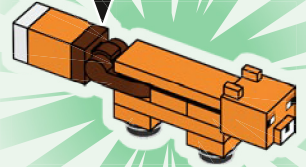
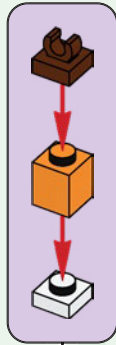

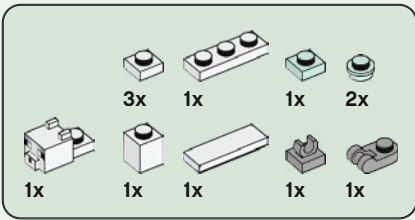

1

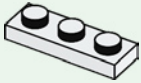

2

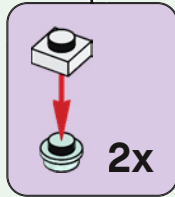
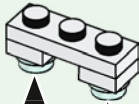

3

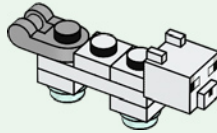

4

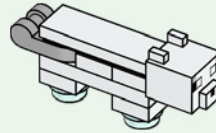

5

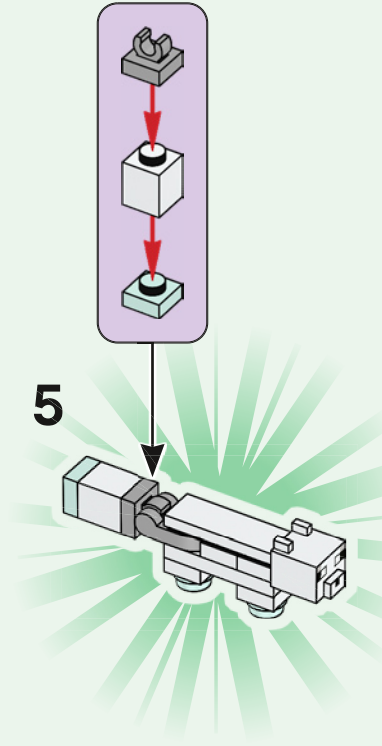

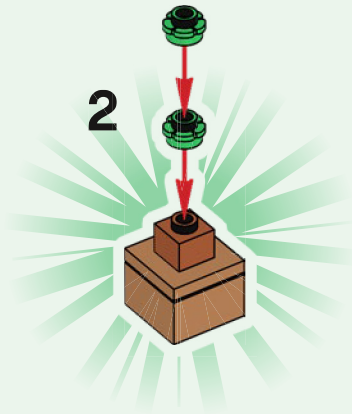
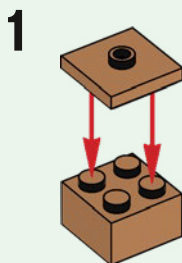
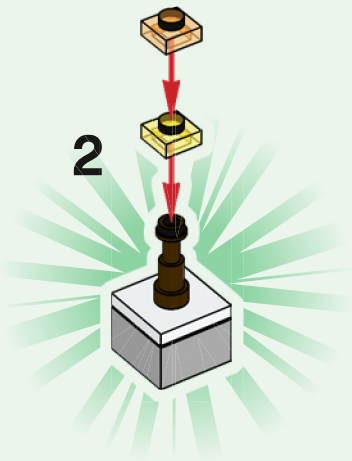
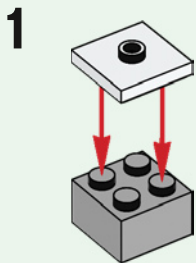
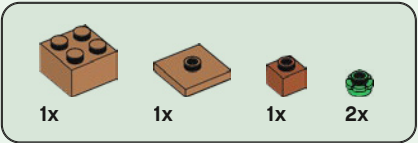
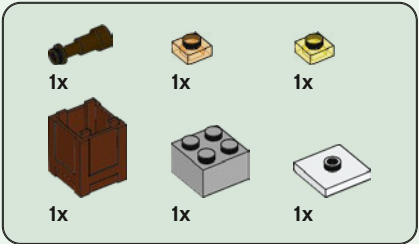

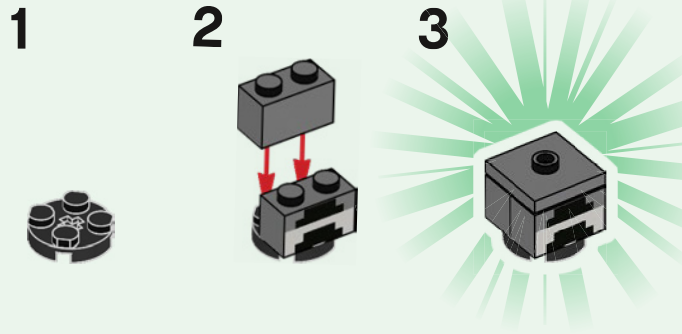
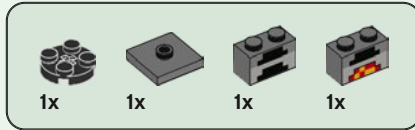
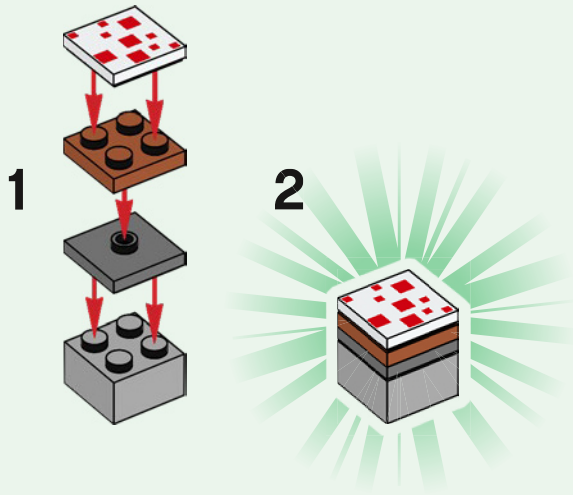
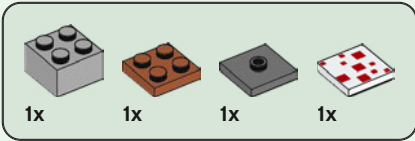

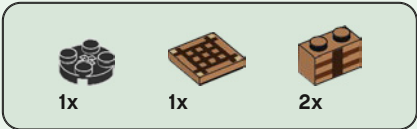

1



2

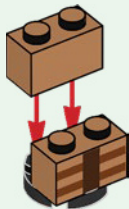

3

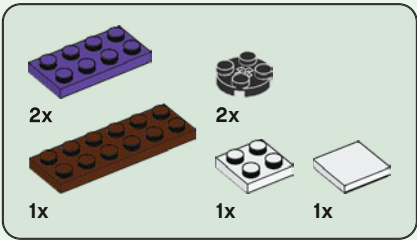

1

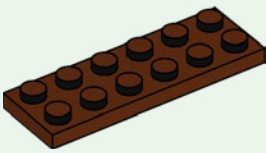

2

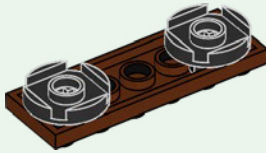

3

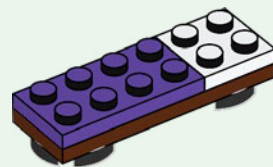

4



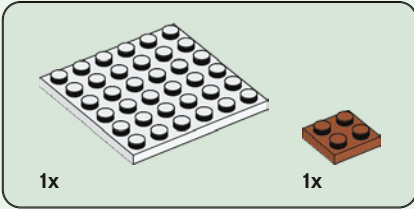
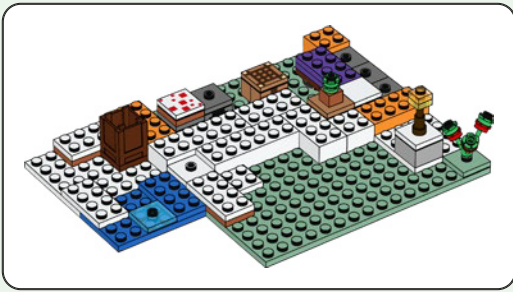

1

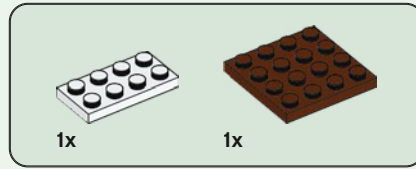
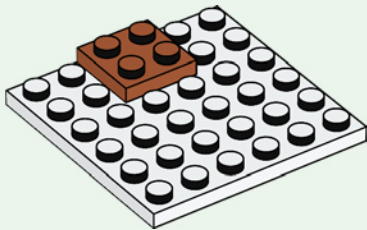

2

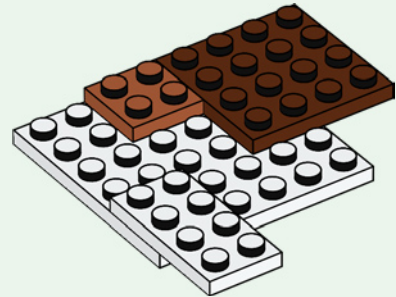

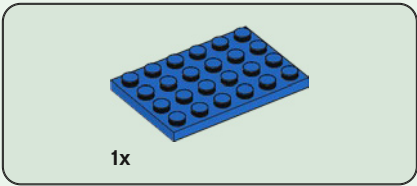

3

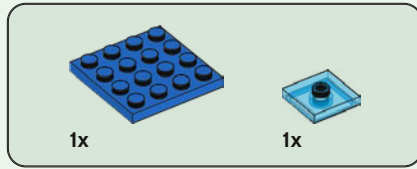
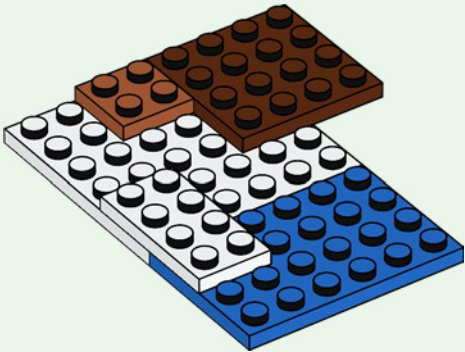

4

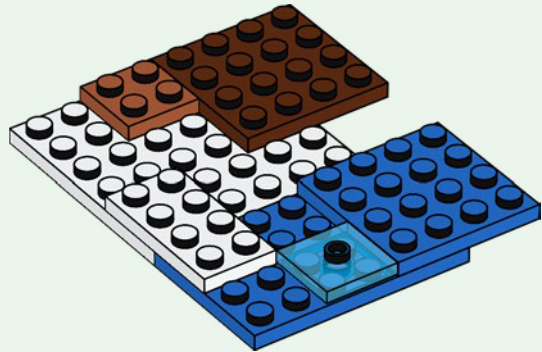

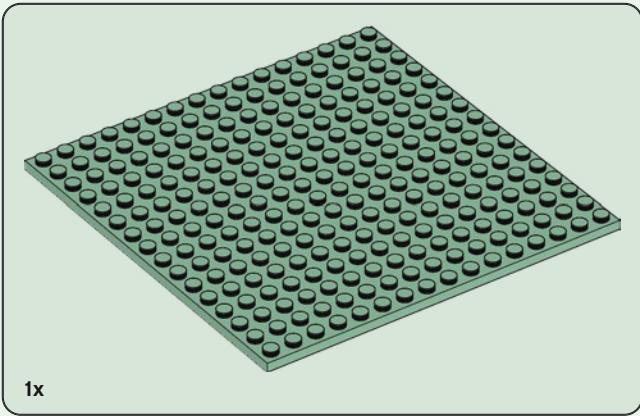

5

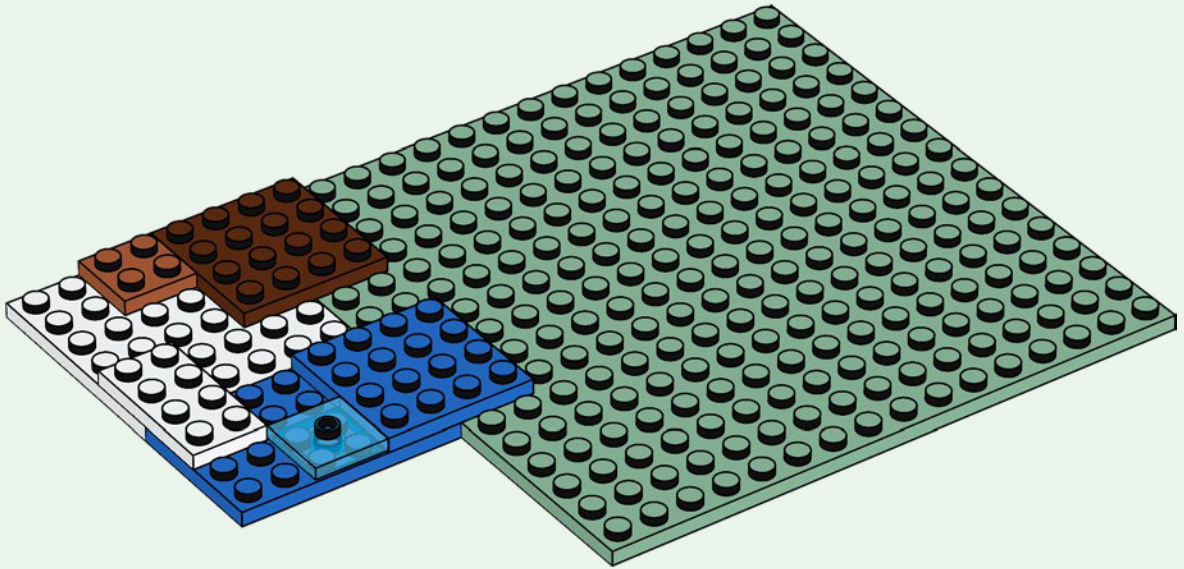



1x



1x

6

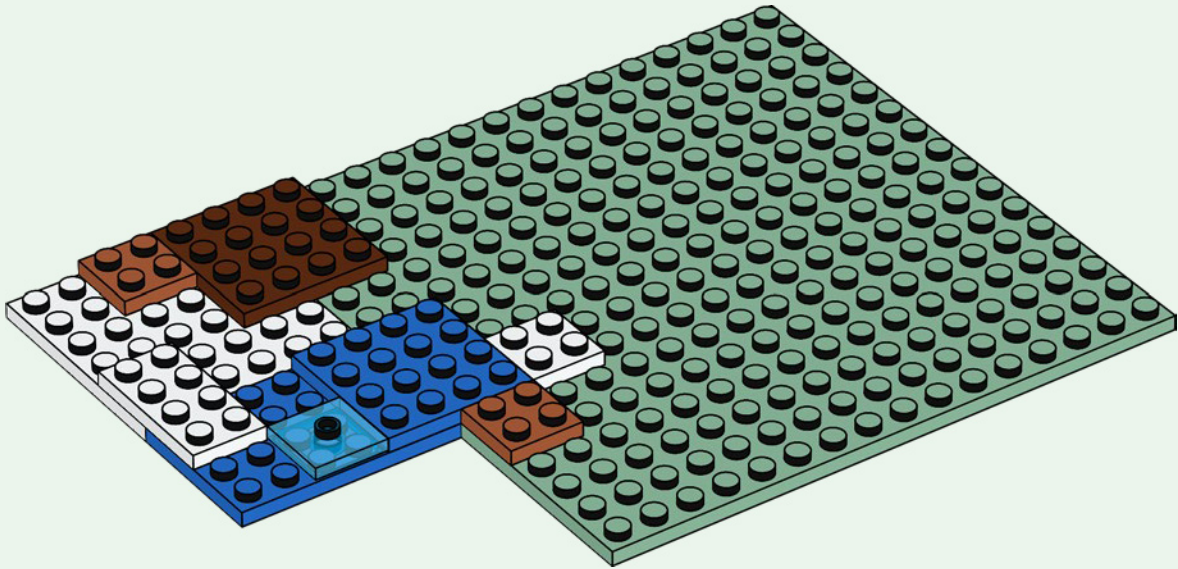

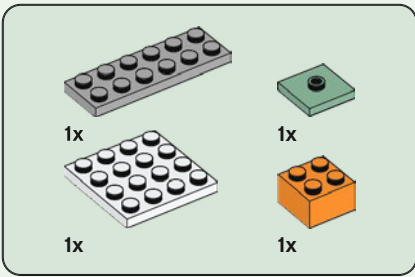

7

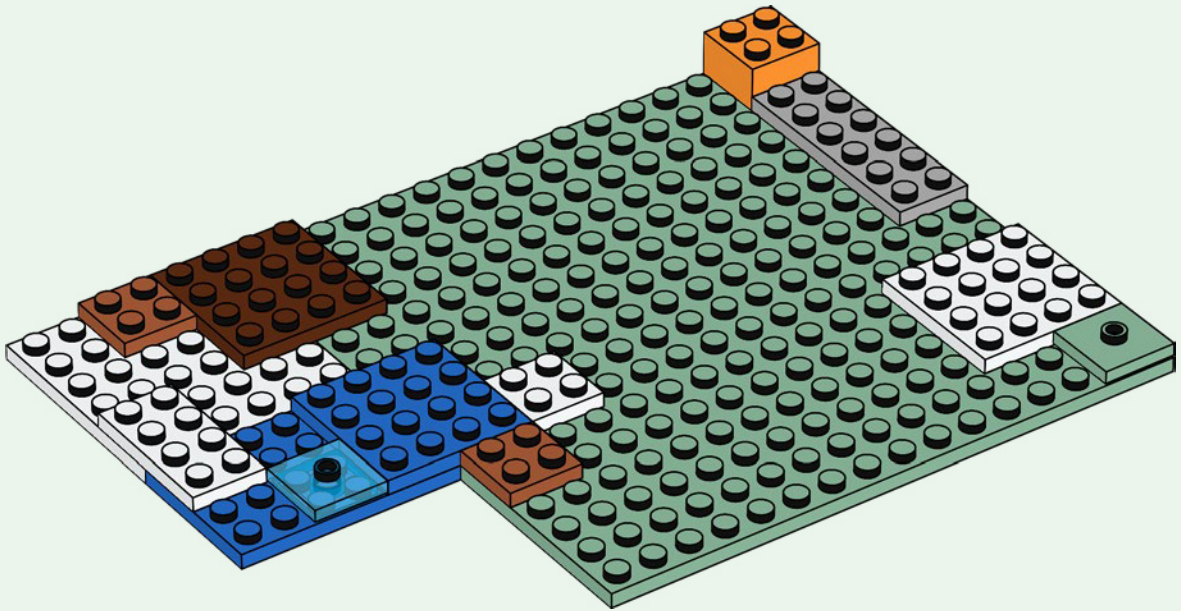



3x

8

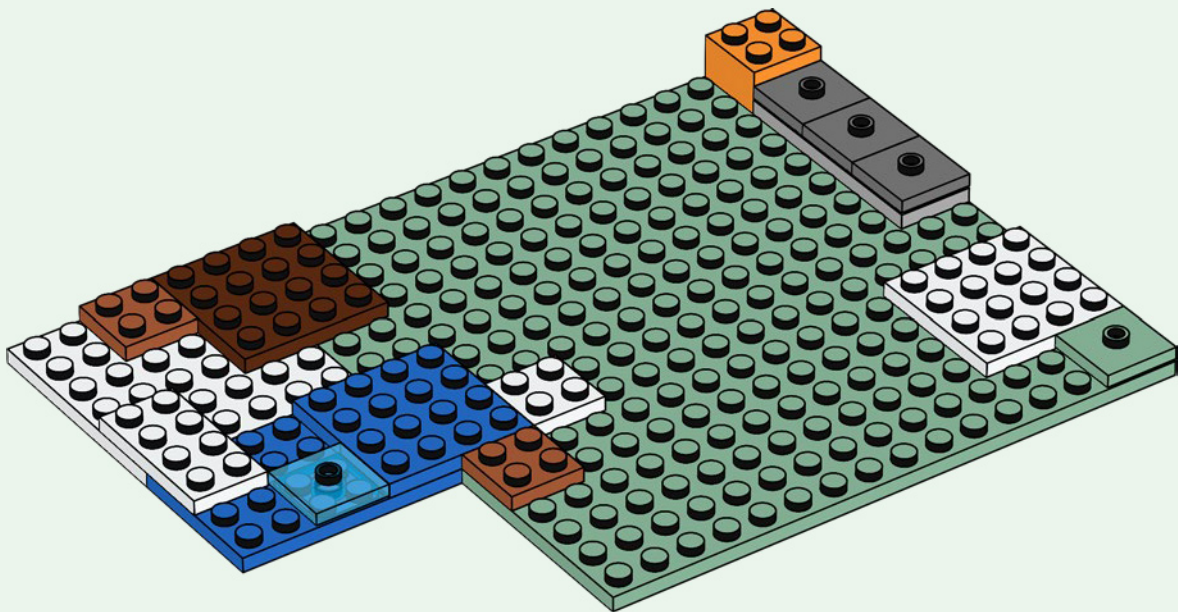

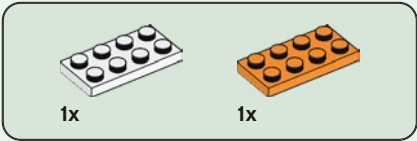

9

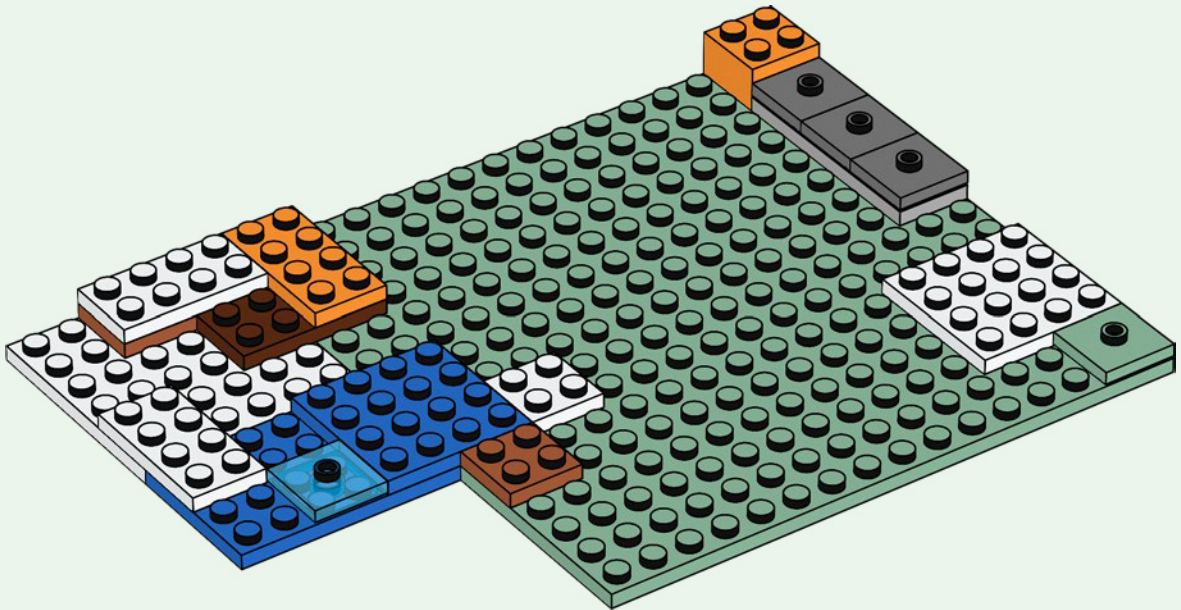

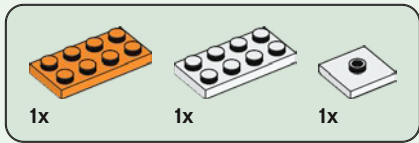

10

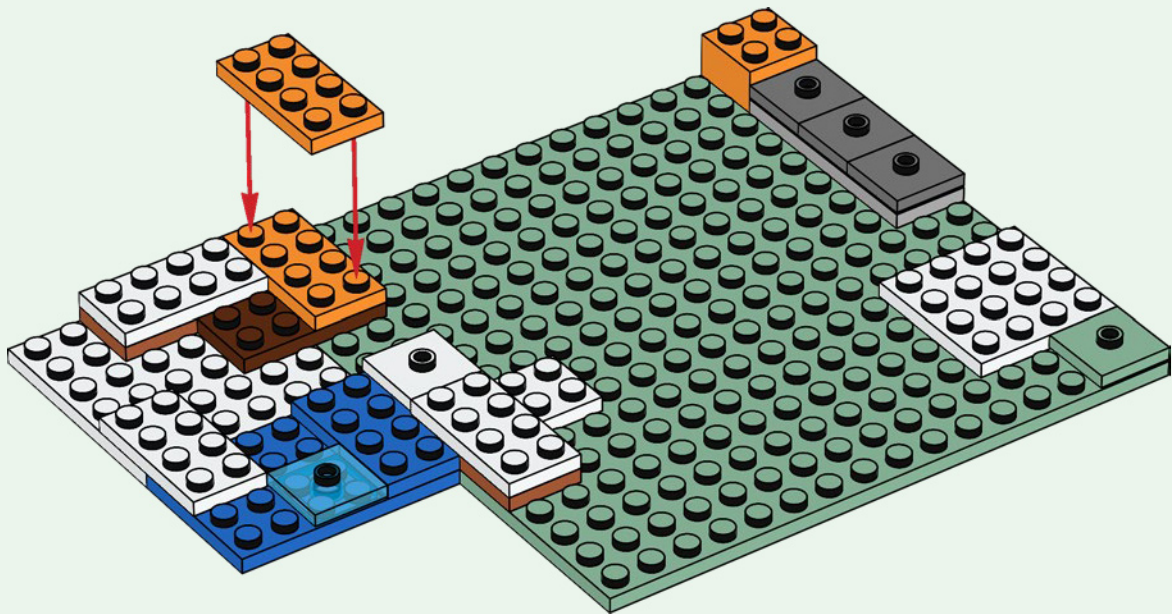

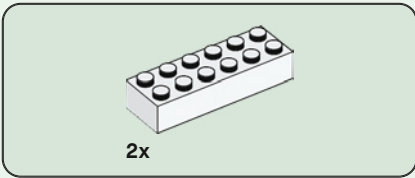

11

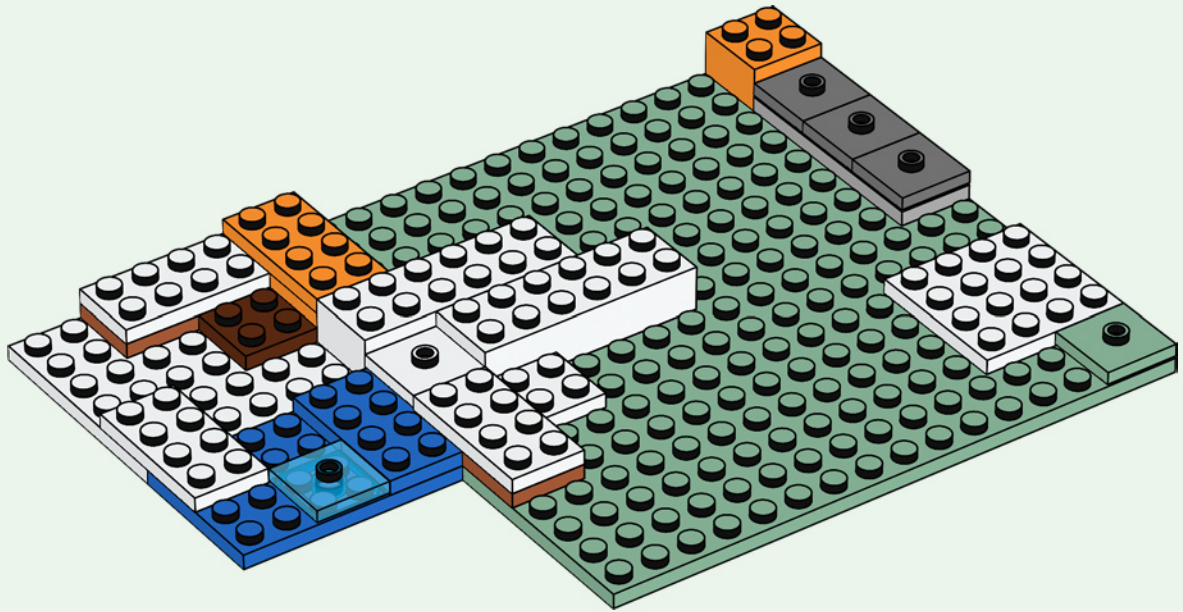

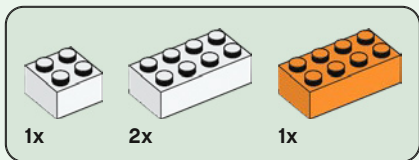

12

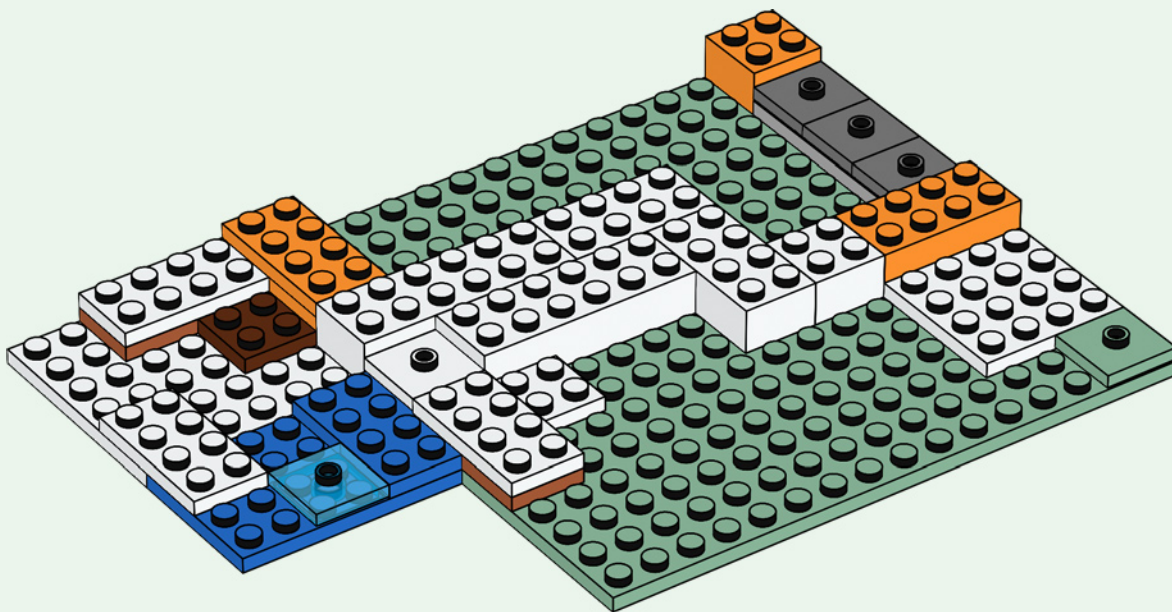

13

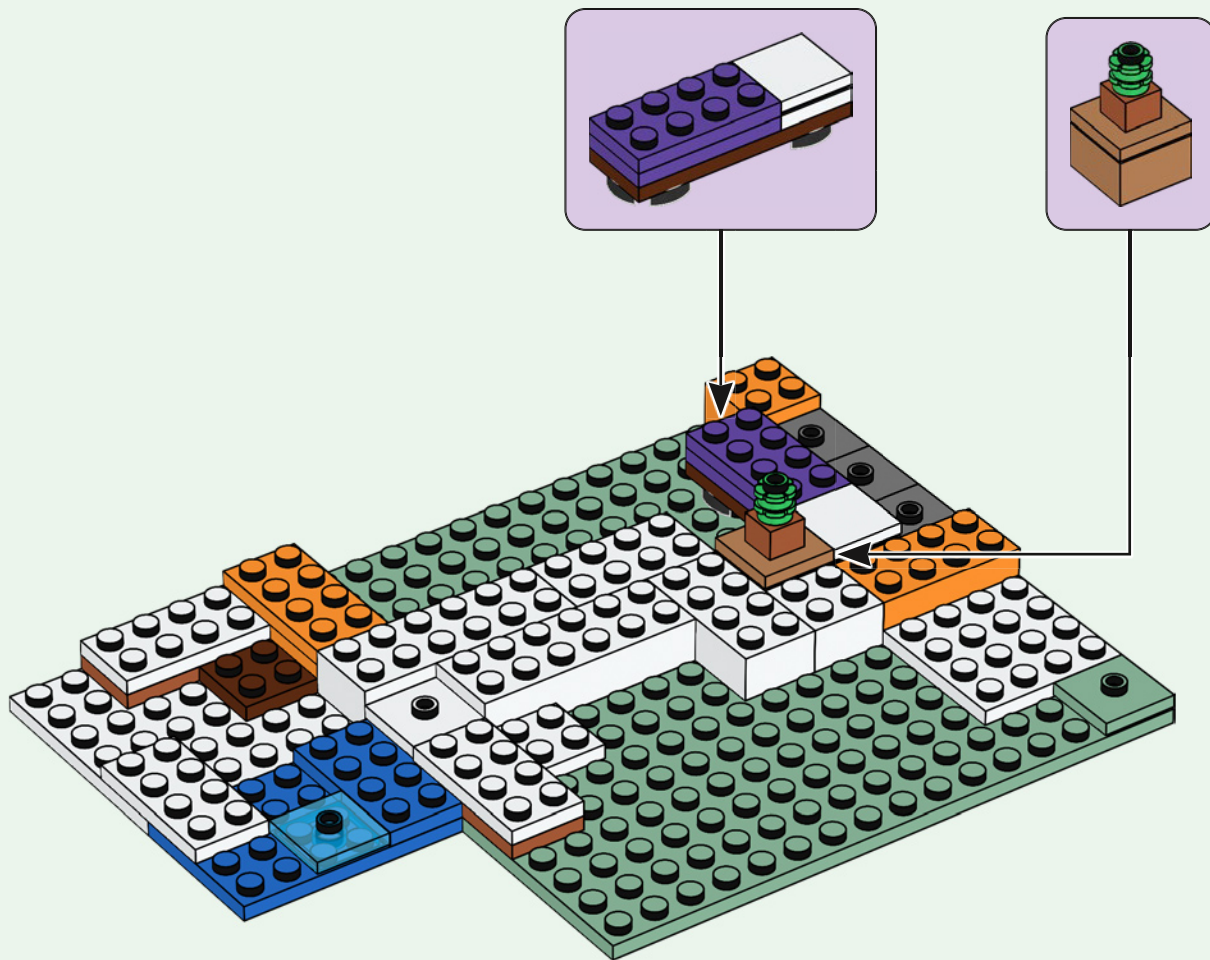



14

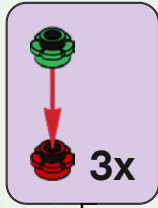

1



2

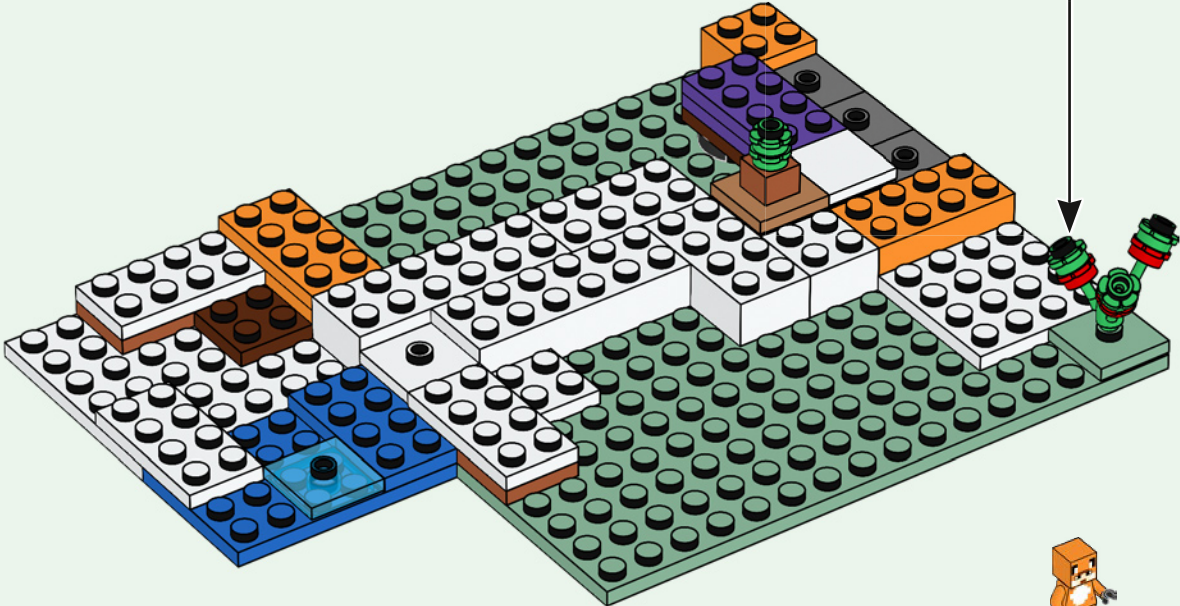
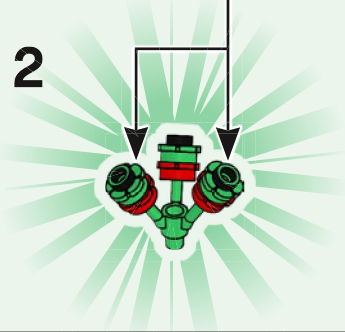

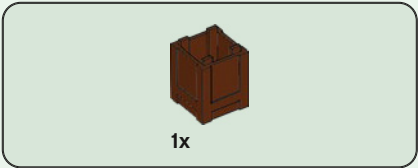

15

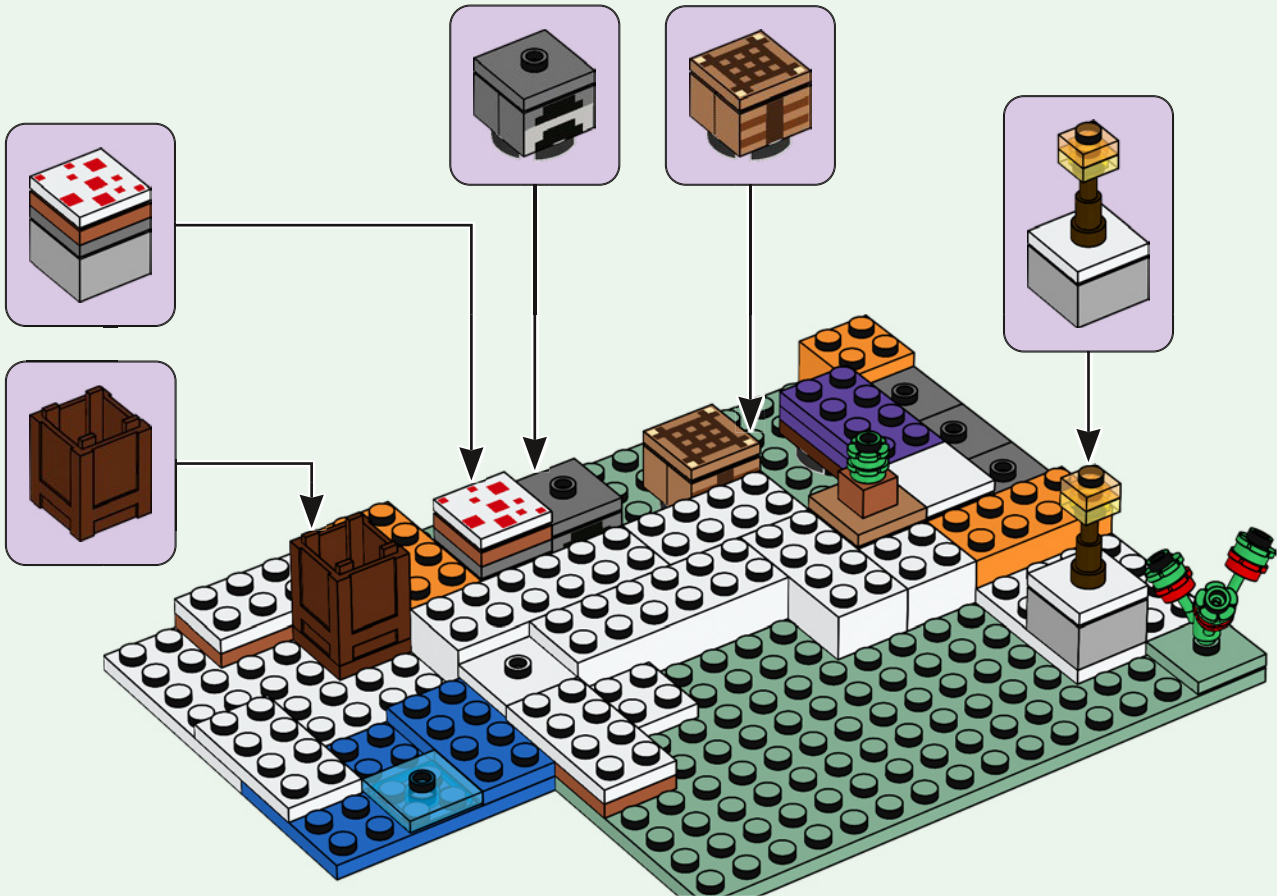

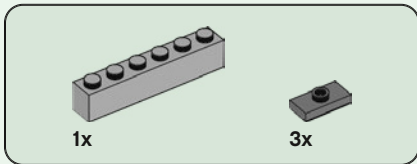
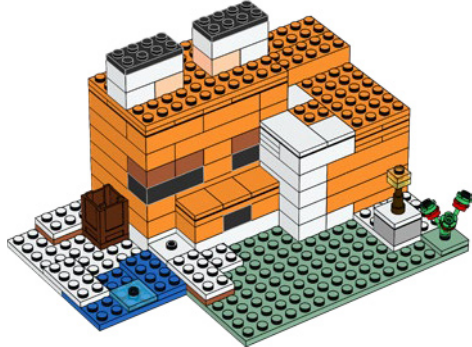
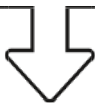

16

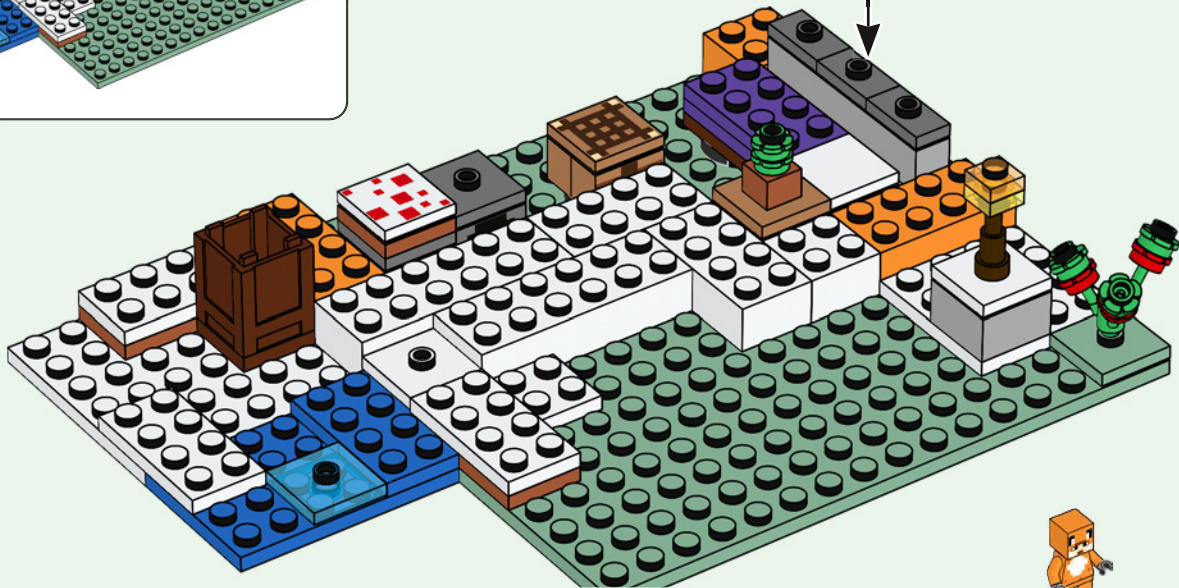
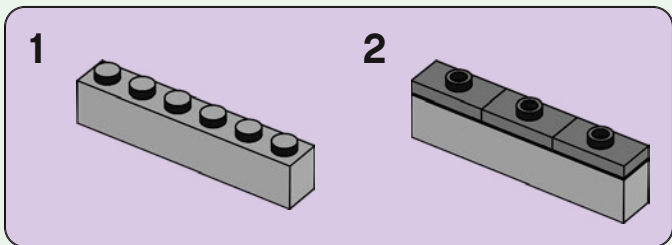



3x

17

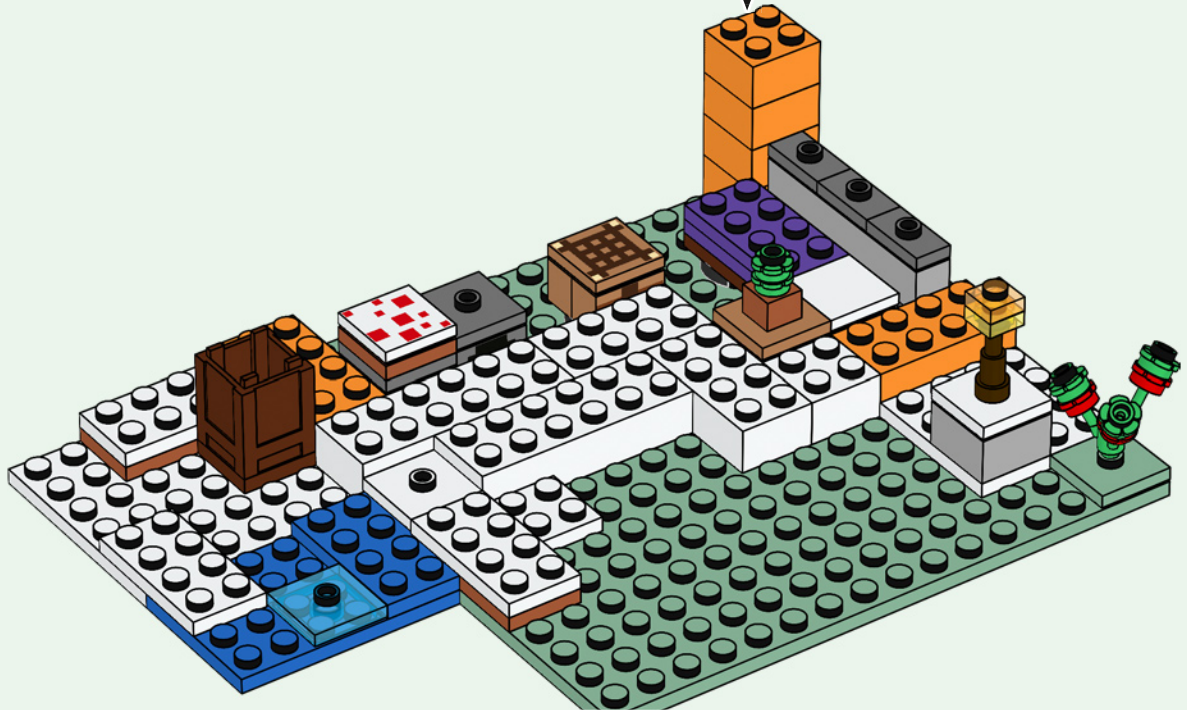
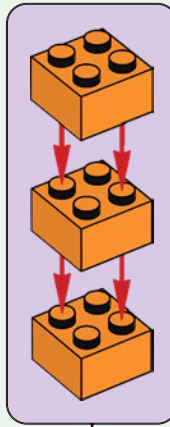



4x

18



2x

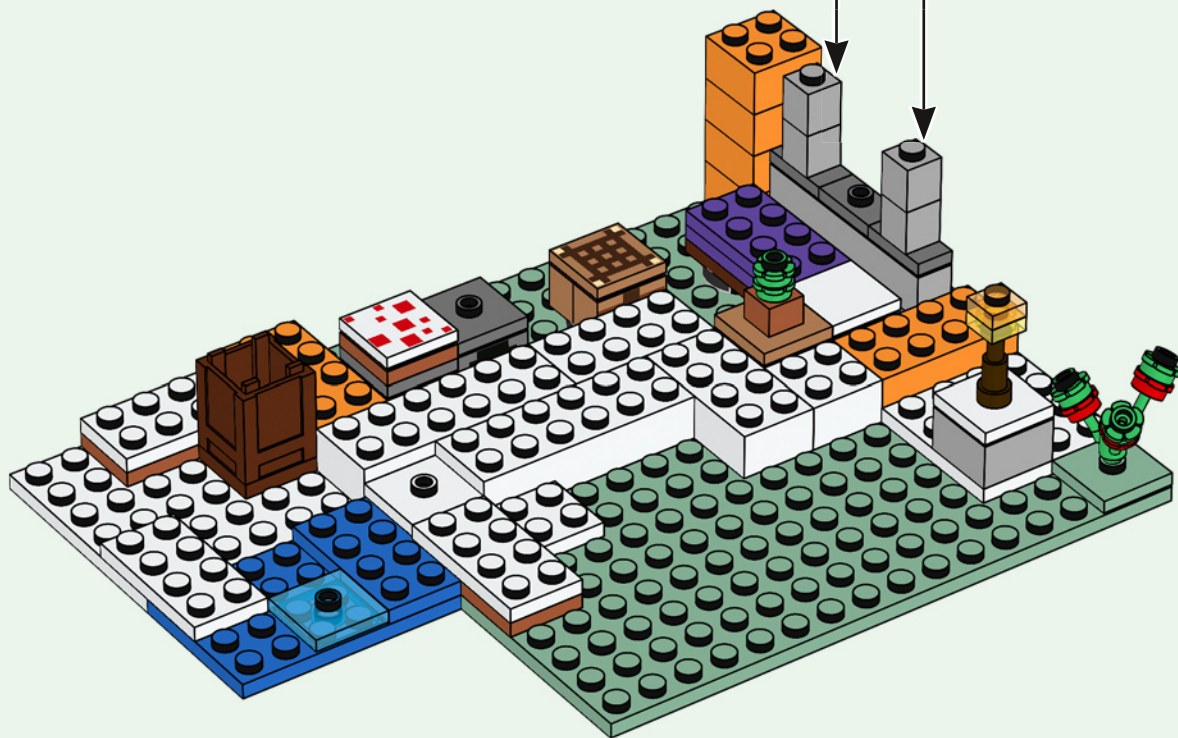

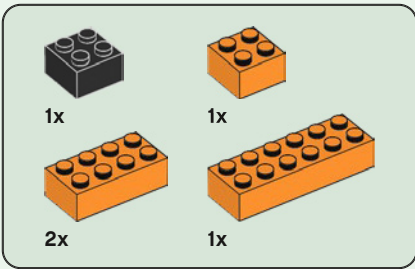

19

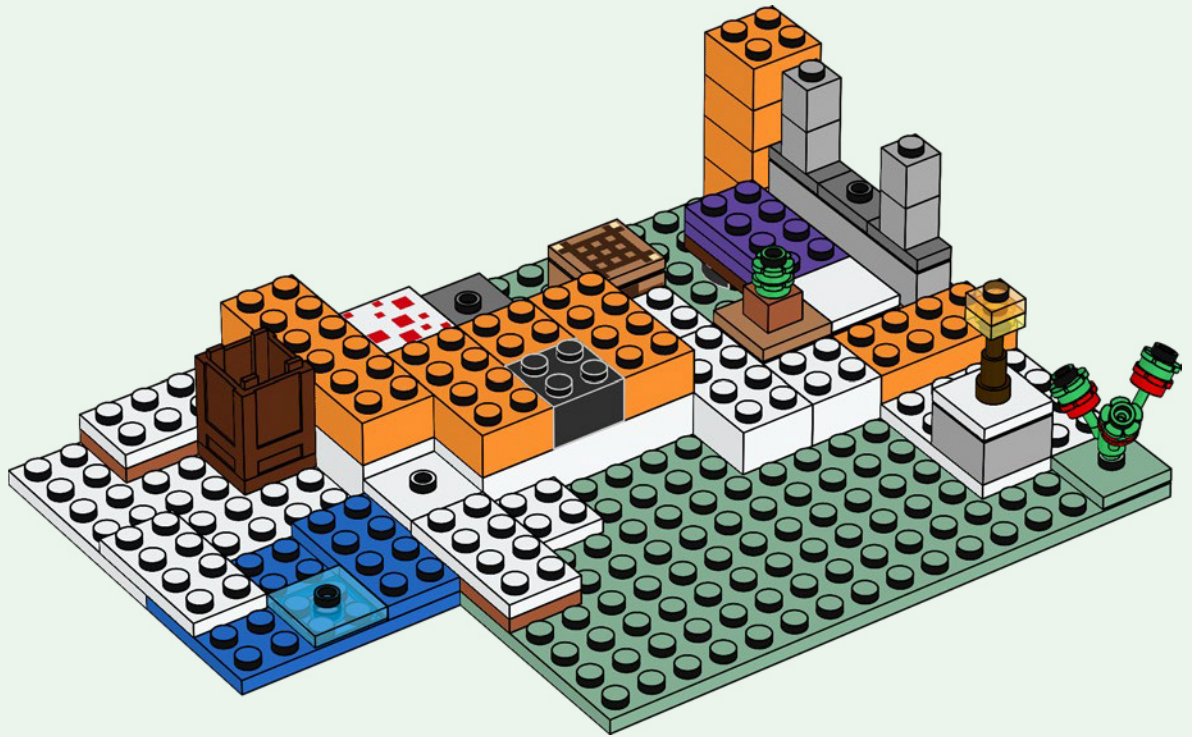

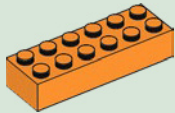

2x

20

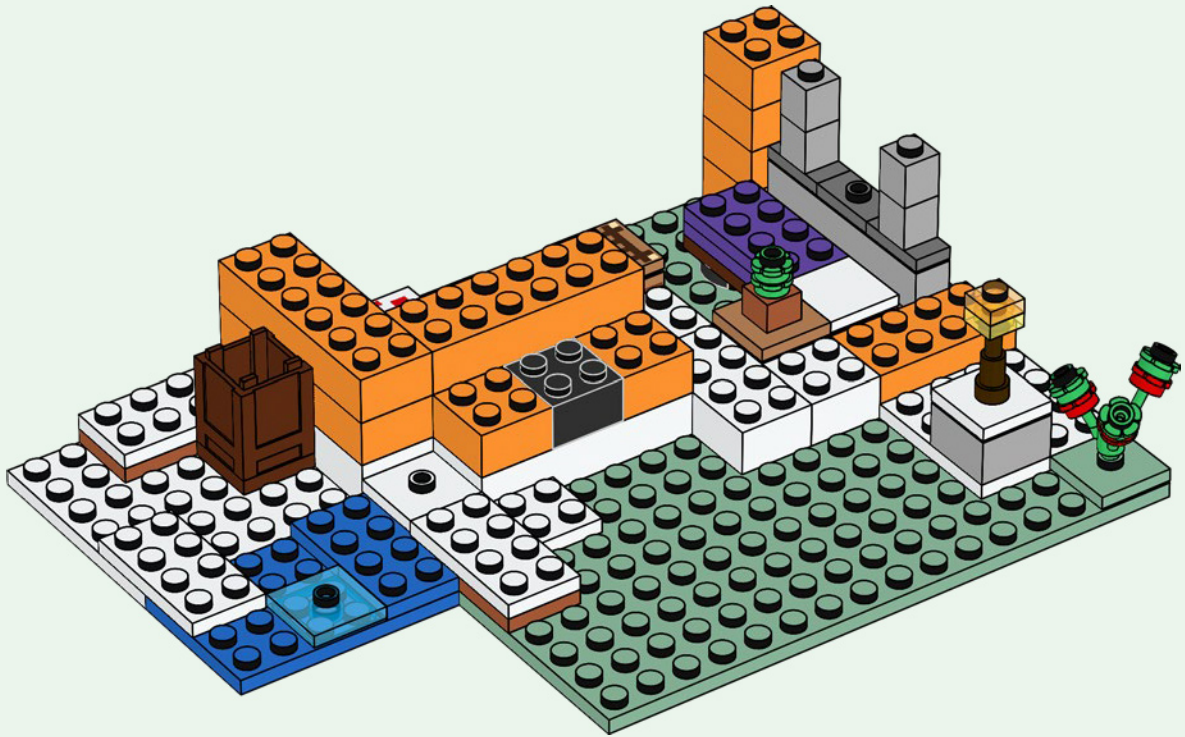

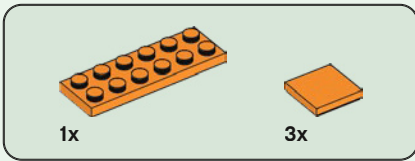

21

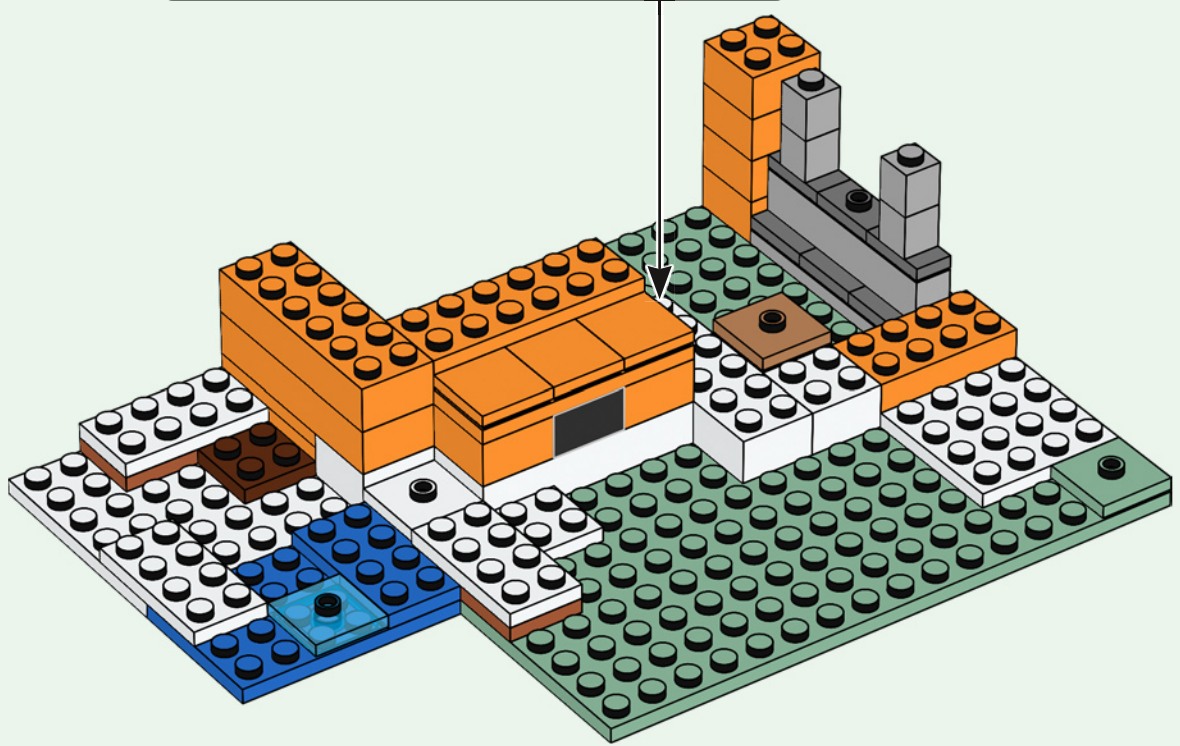
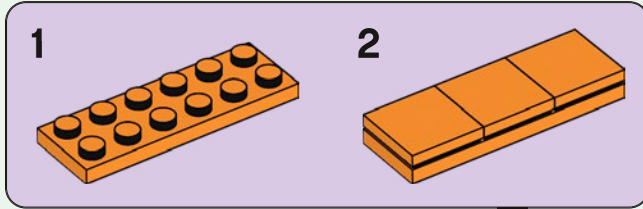



2x

22

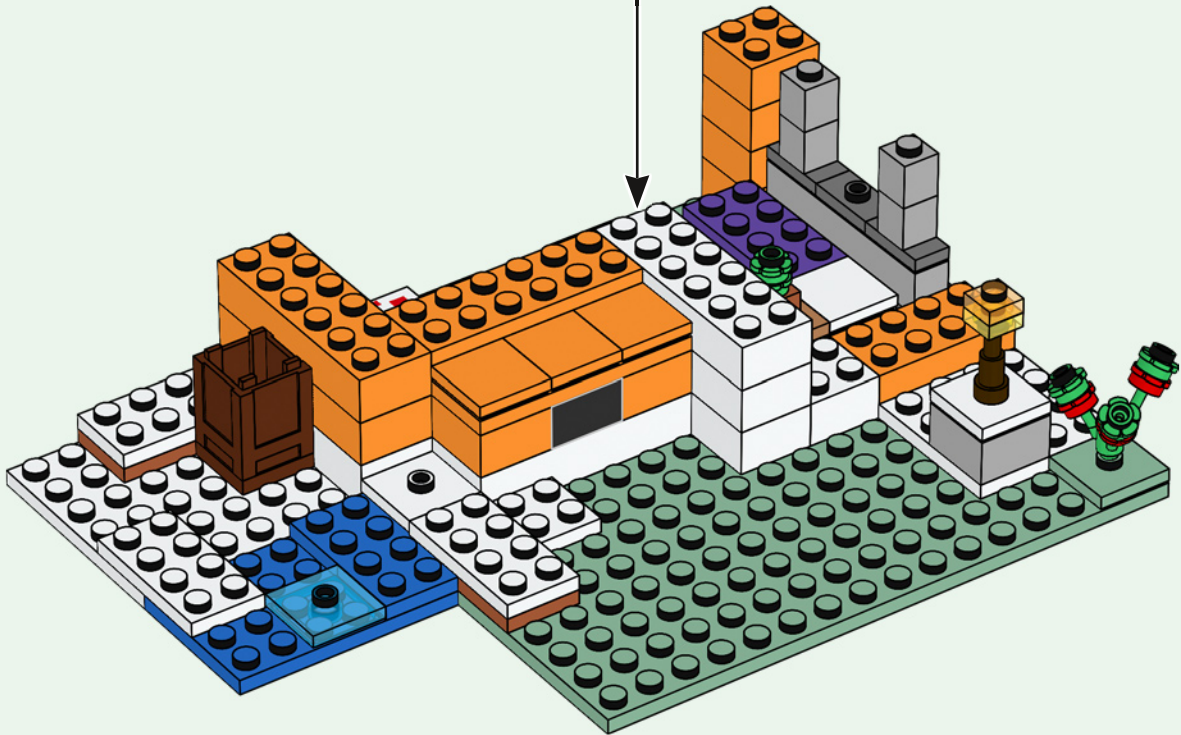
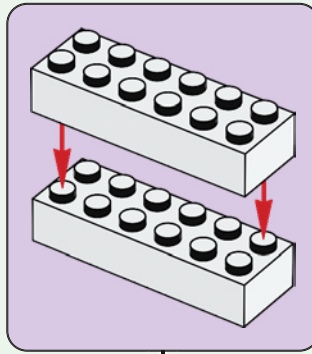

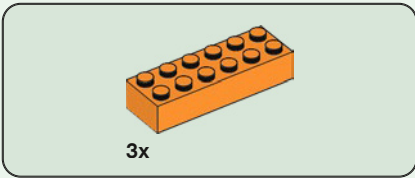

23

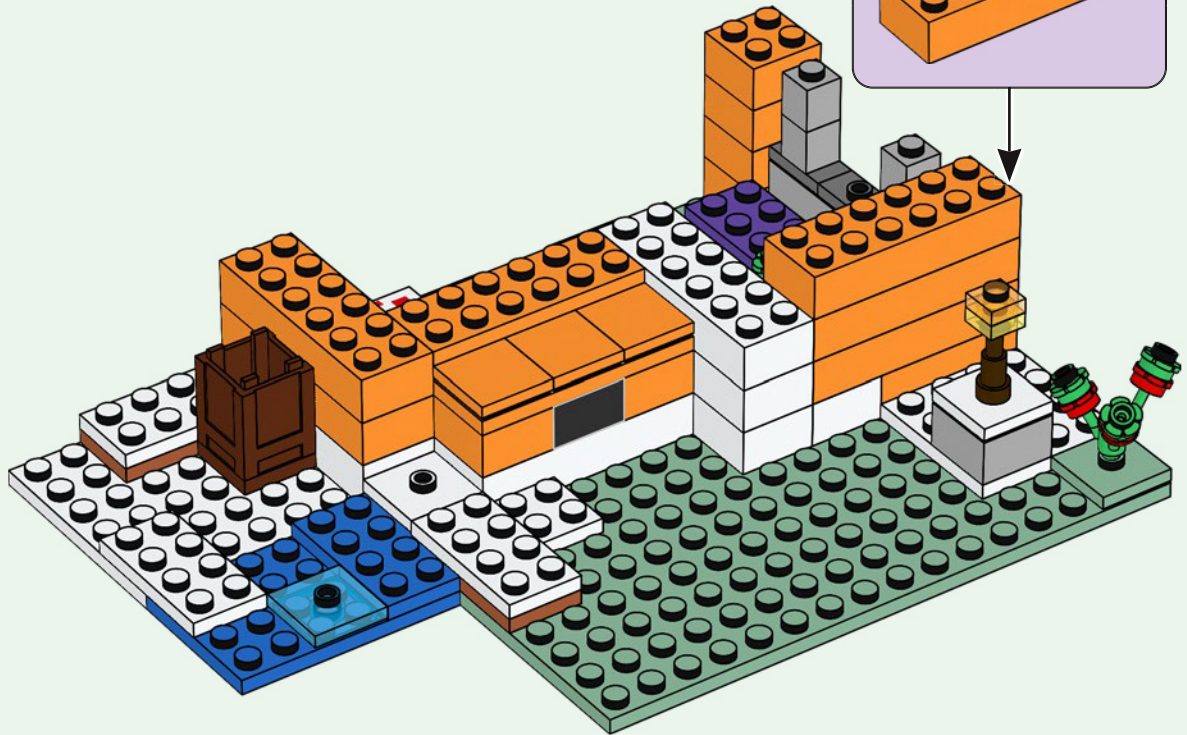
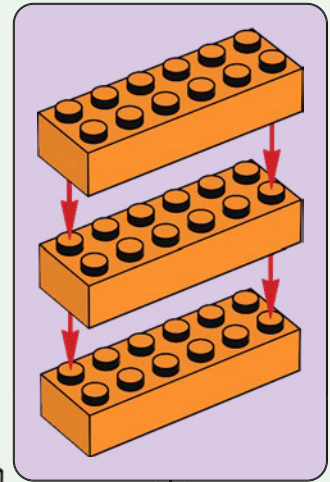



1x



1x

25

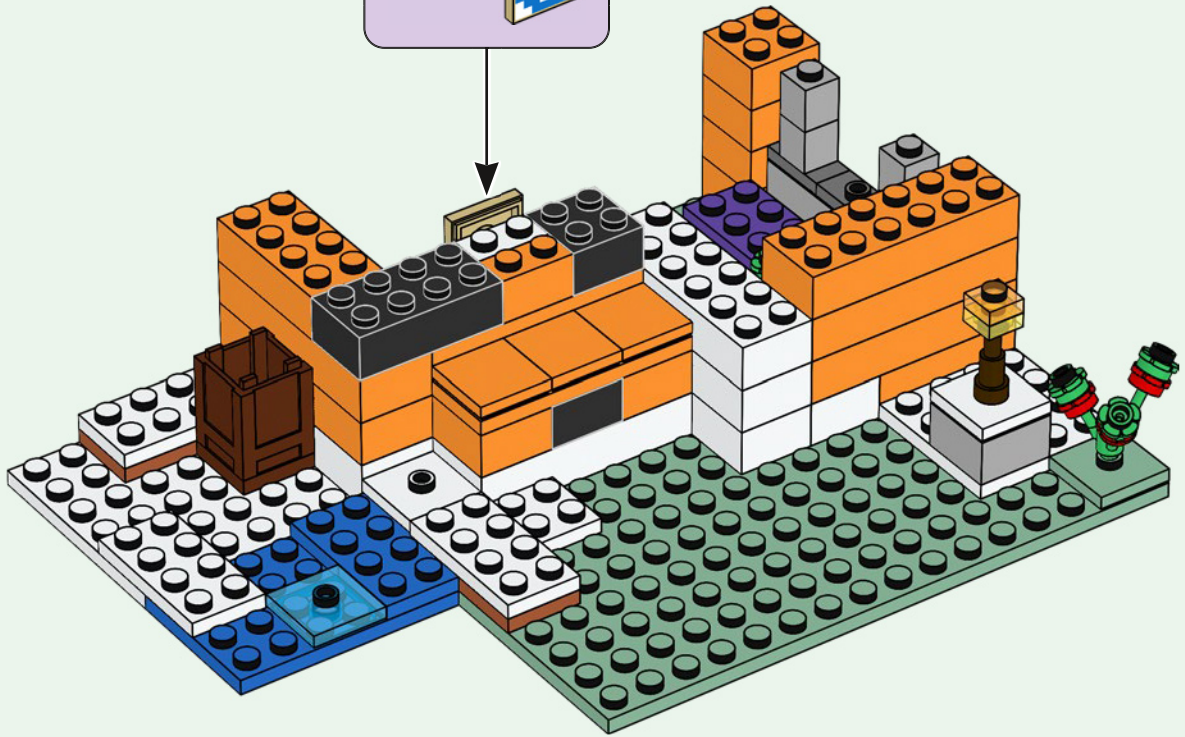
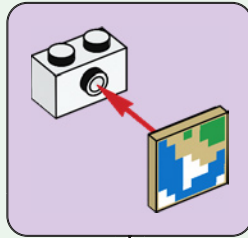

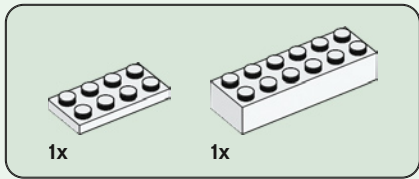

26

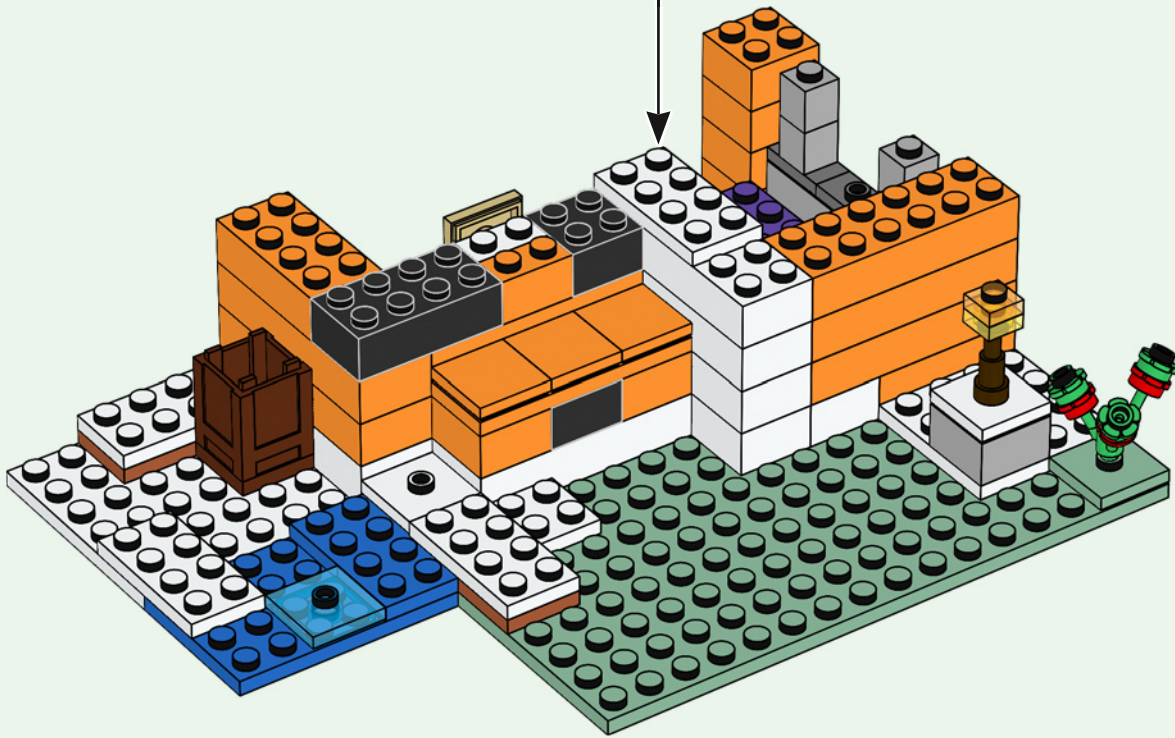
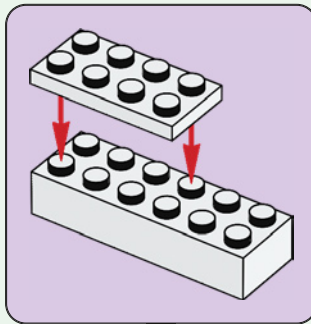

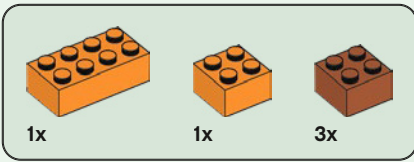

27

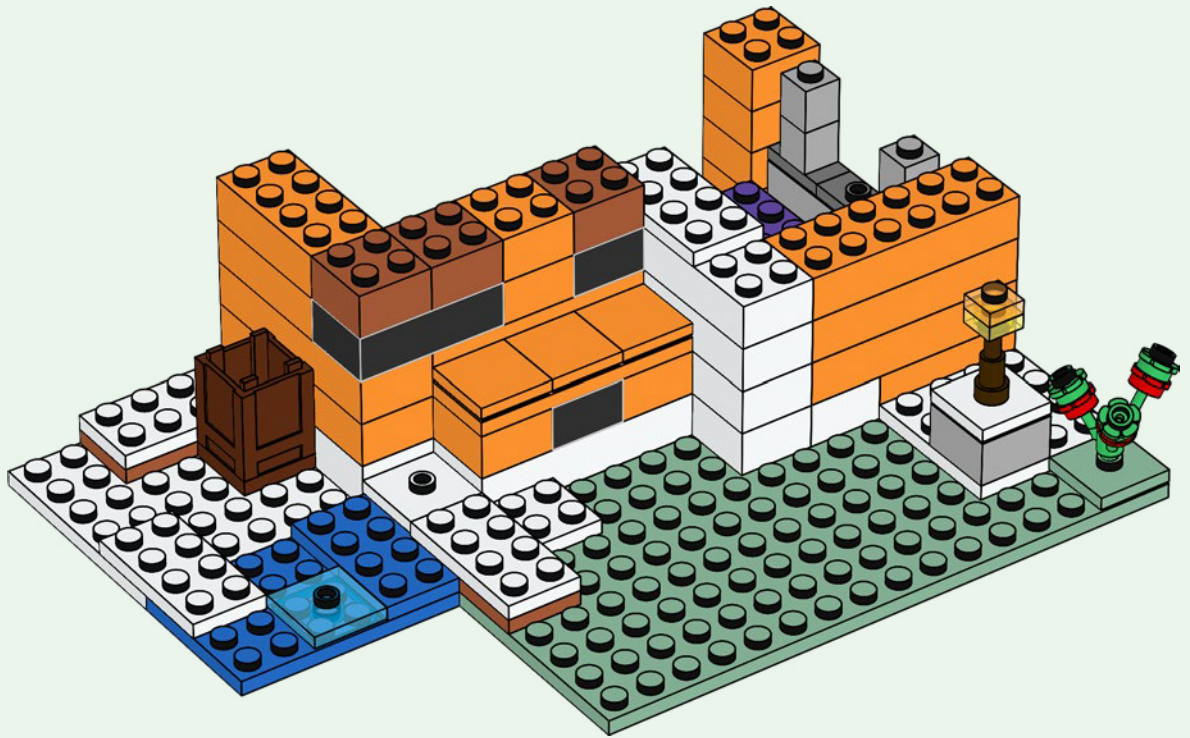

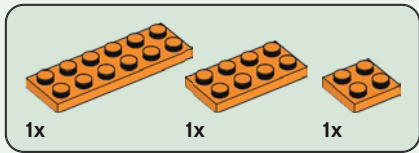

28

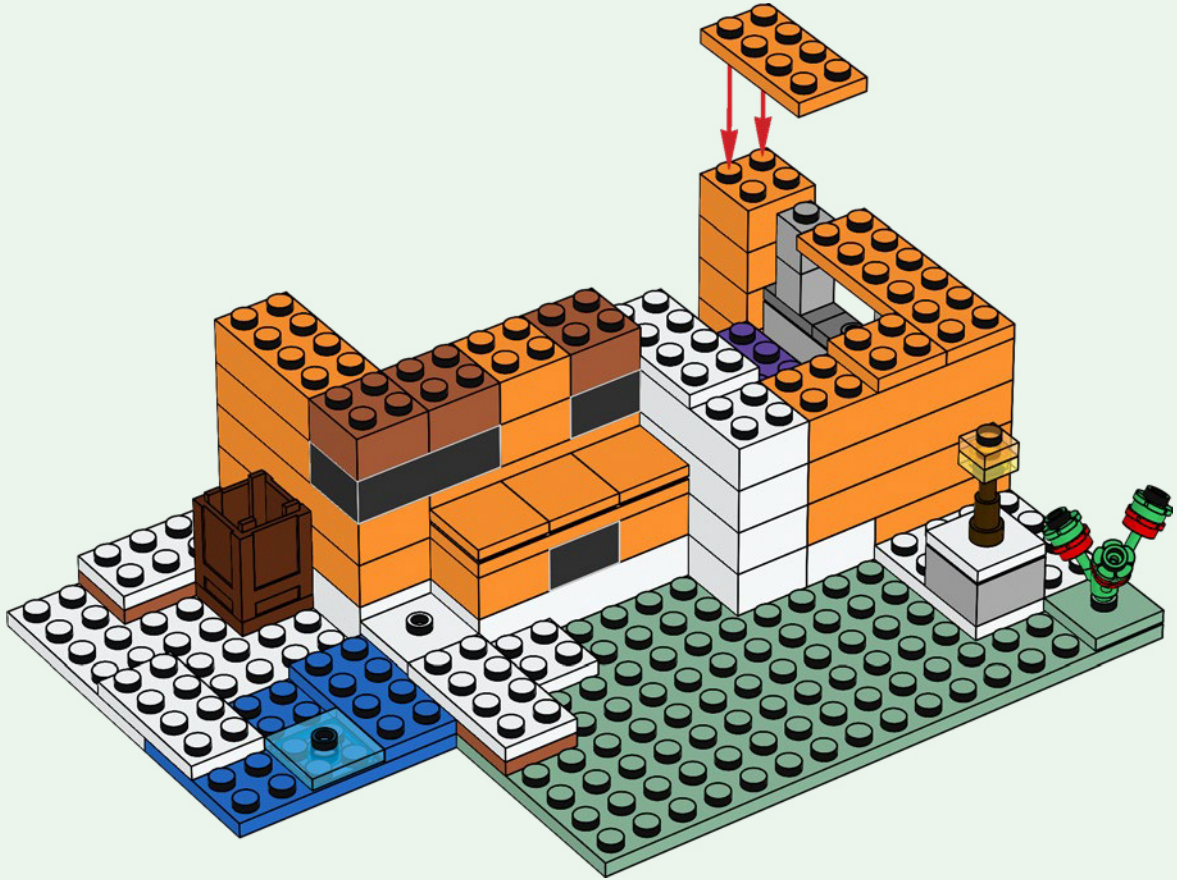

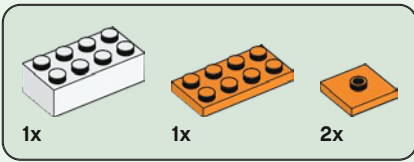

29

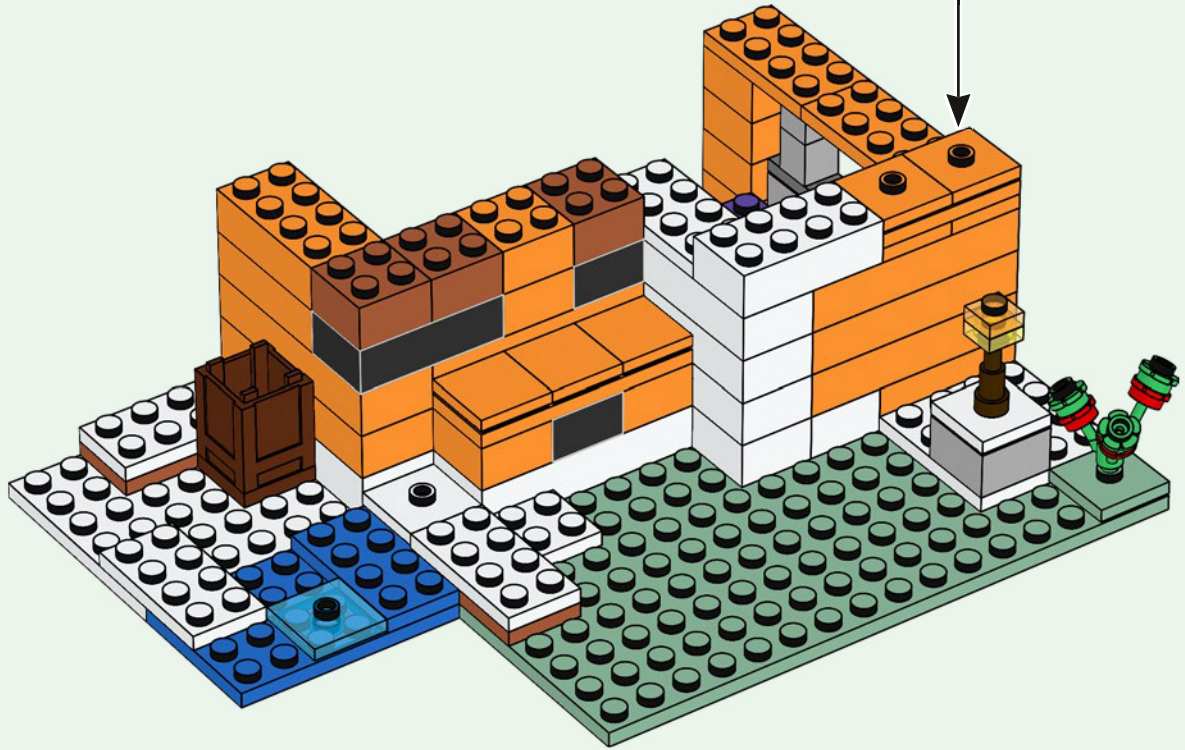
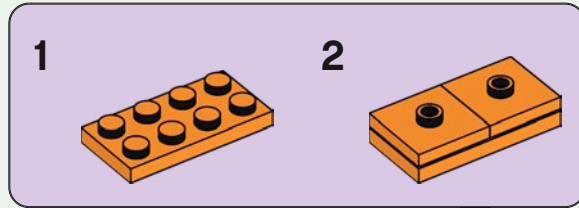

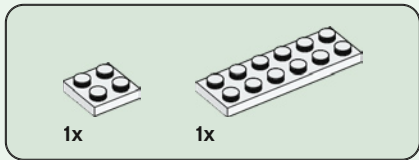

30

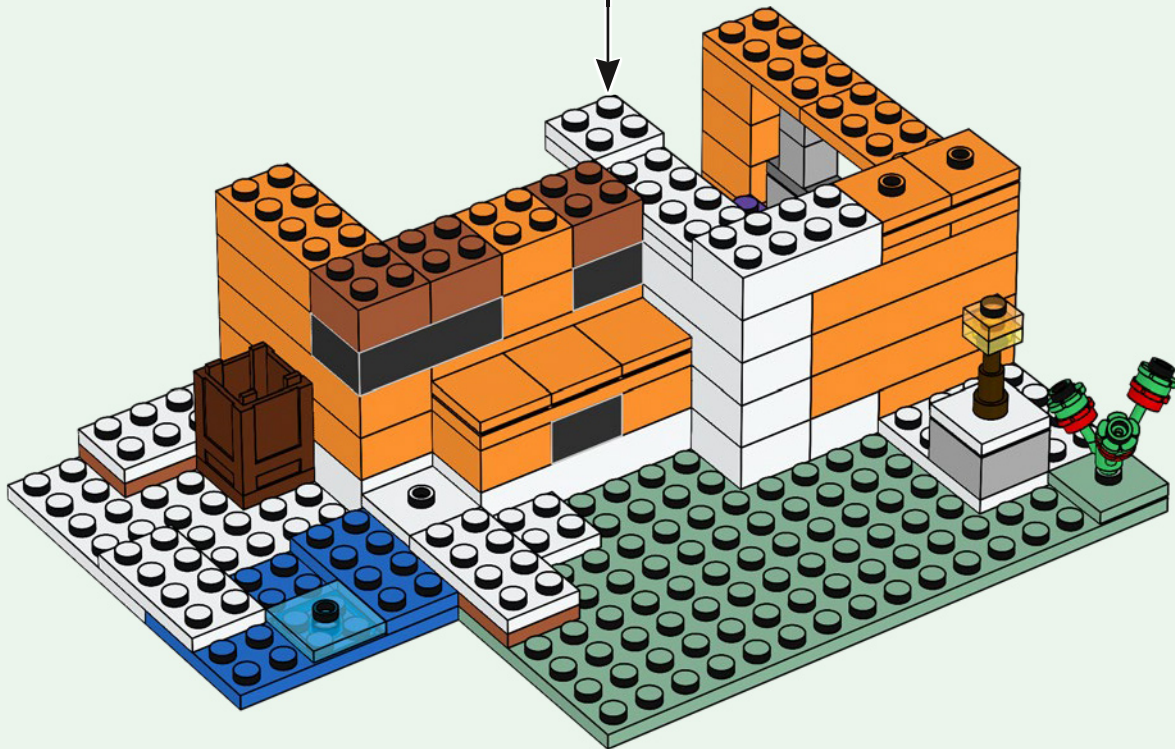
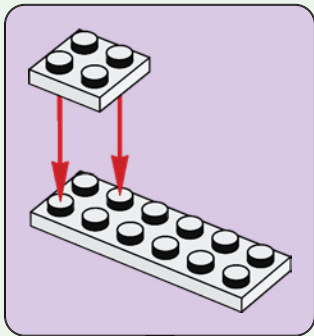

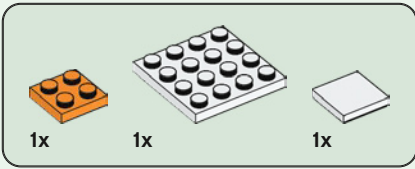

31

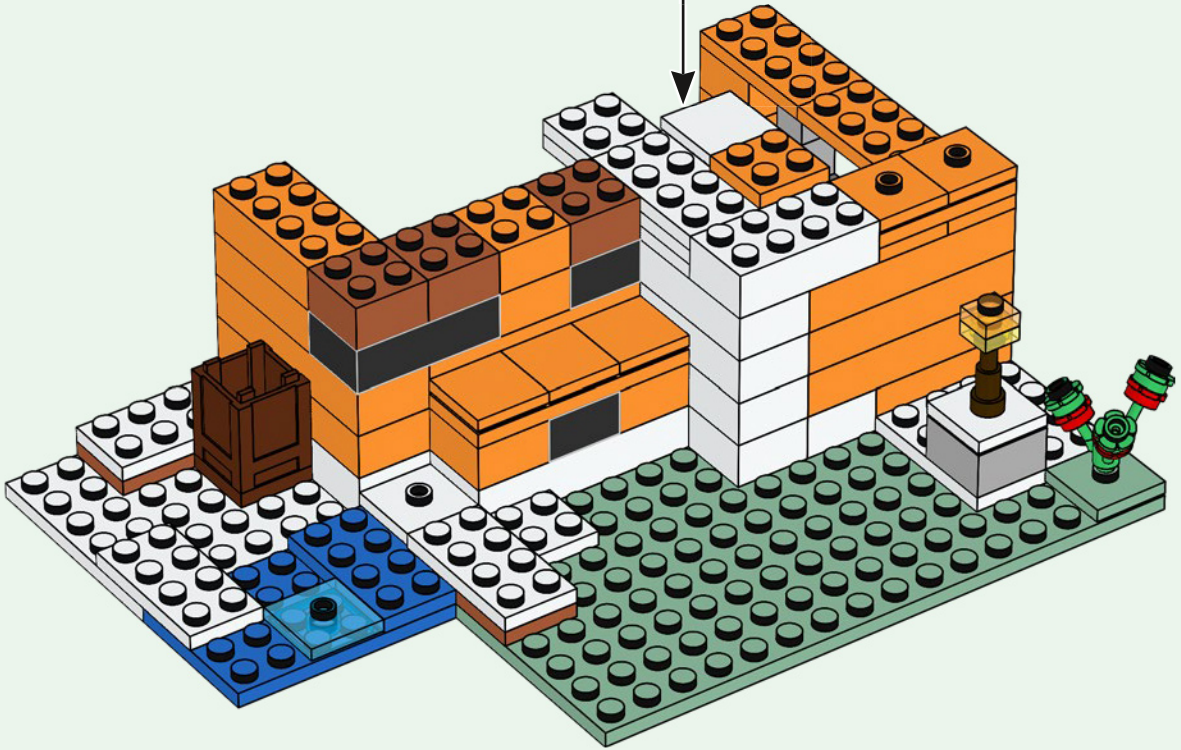
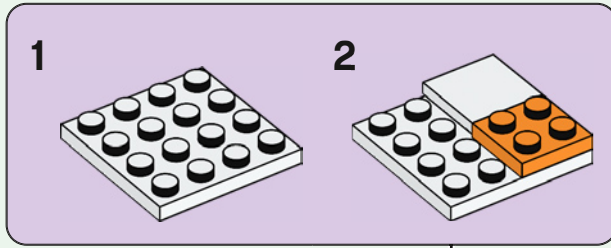

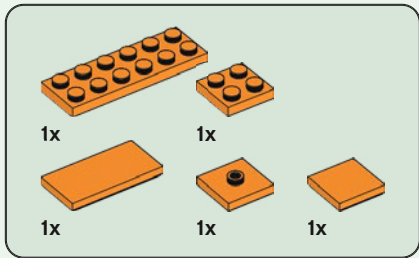

32

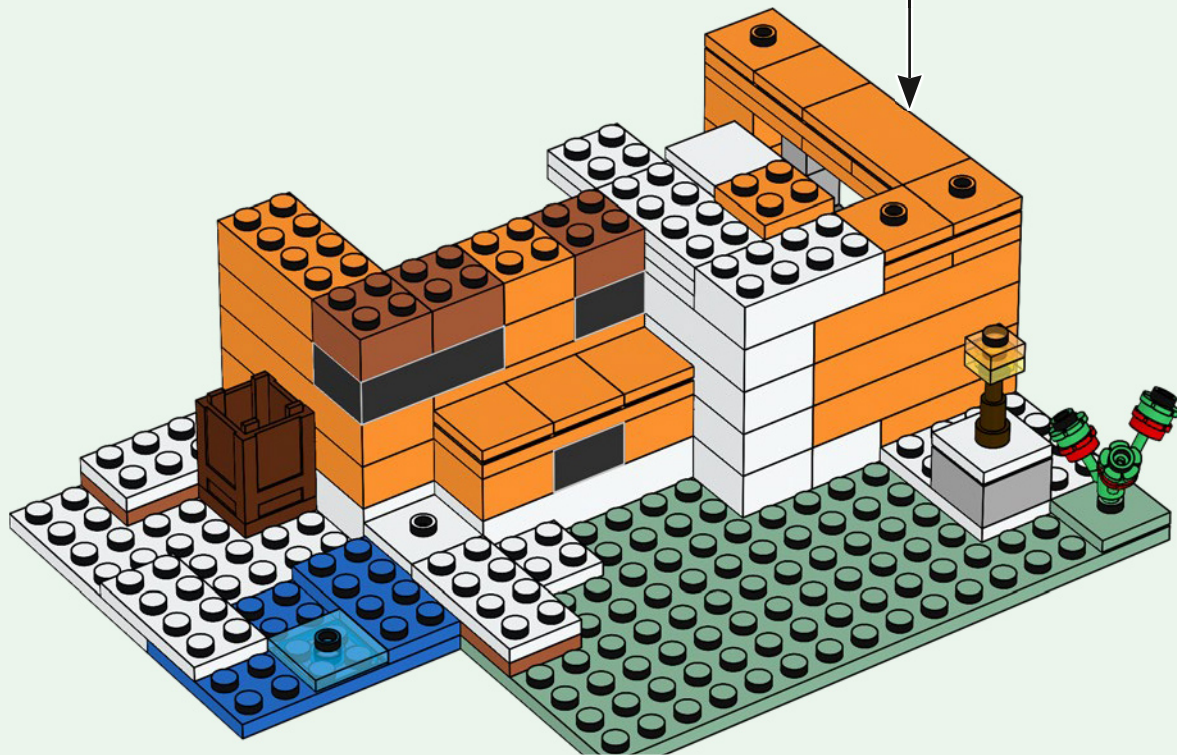
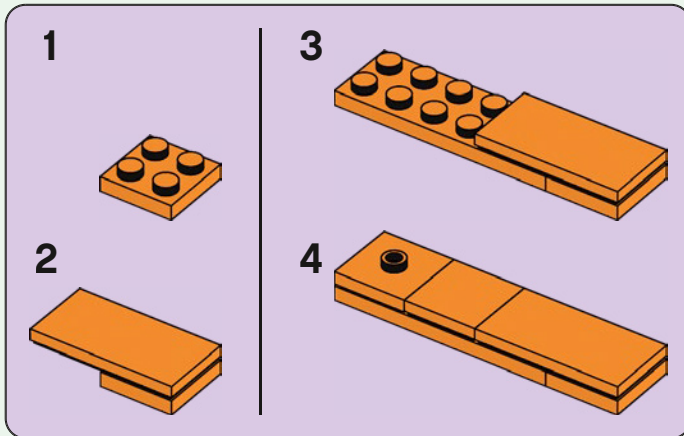

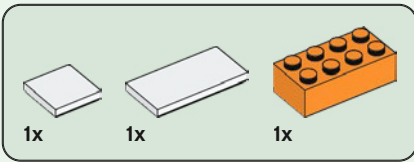

33

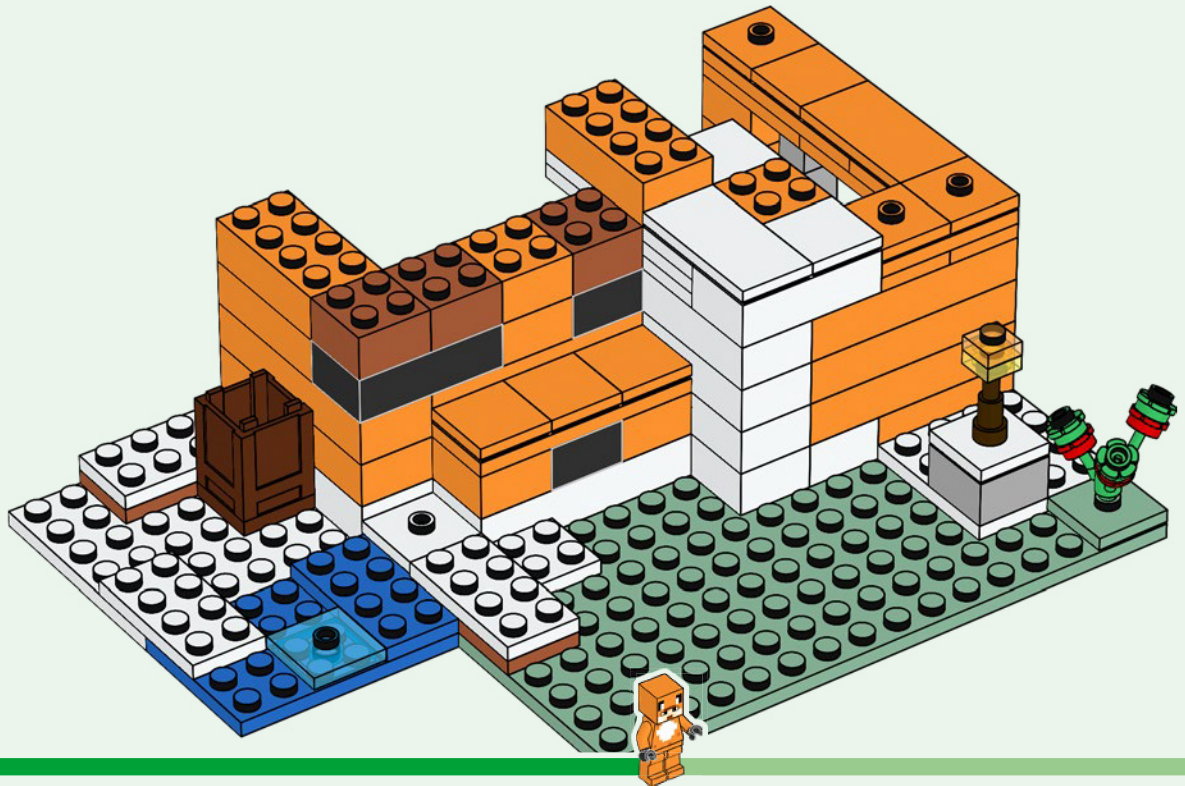

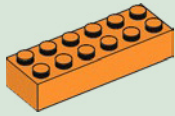

2x

34

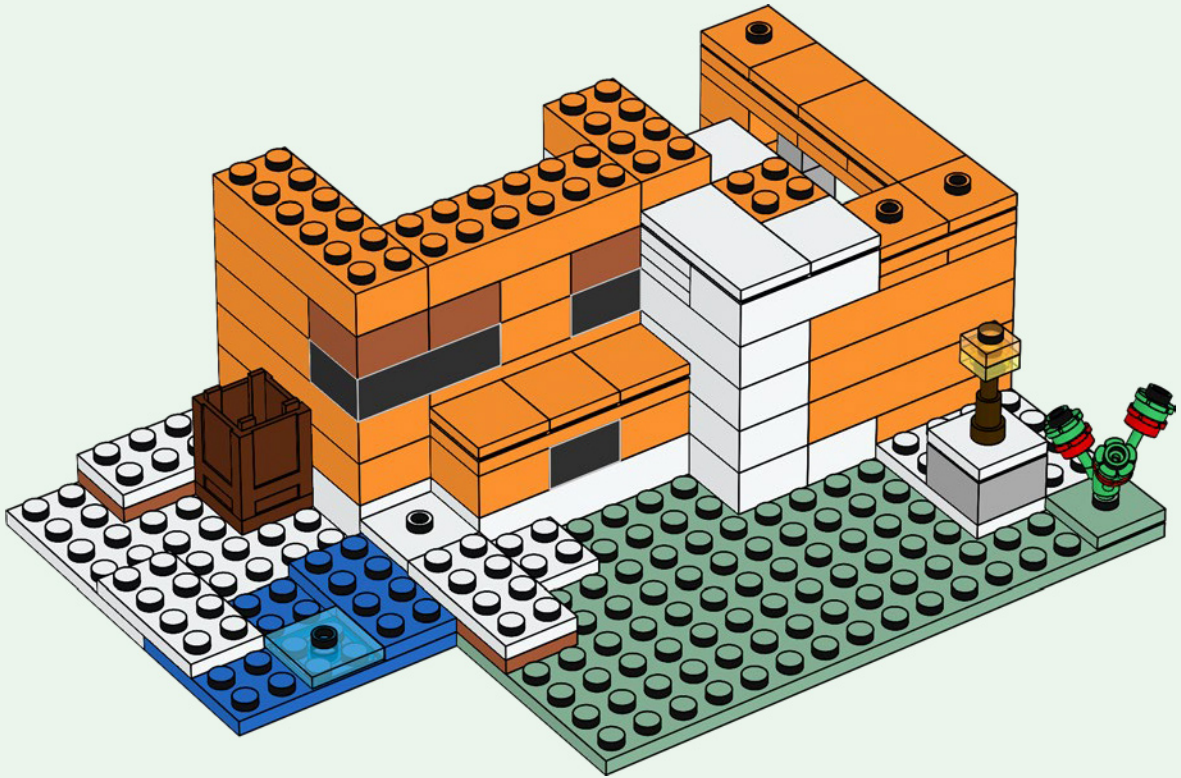

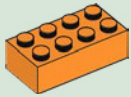

3x

35

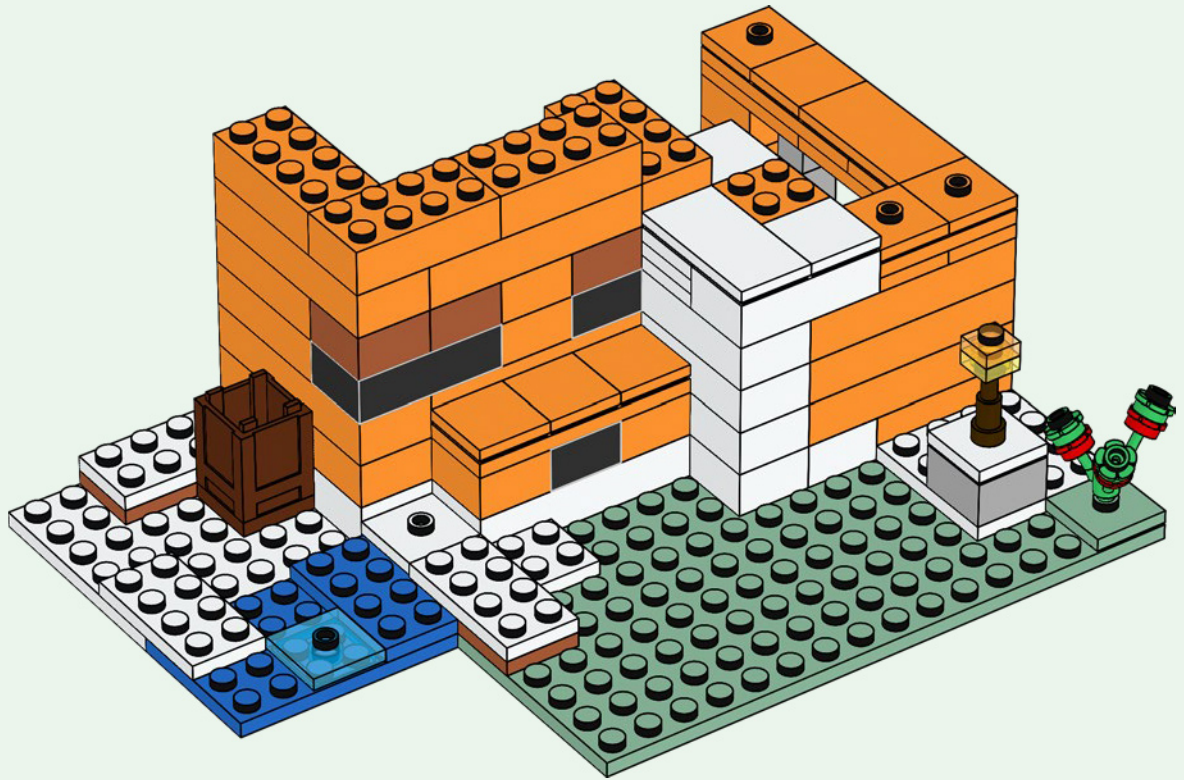

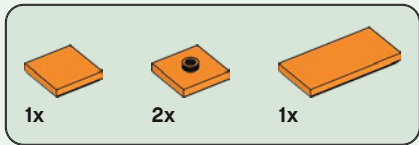

36

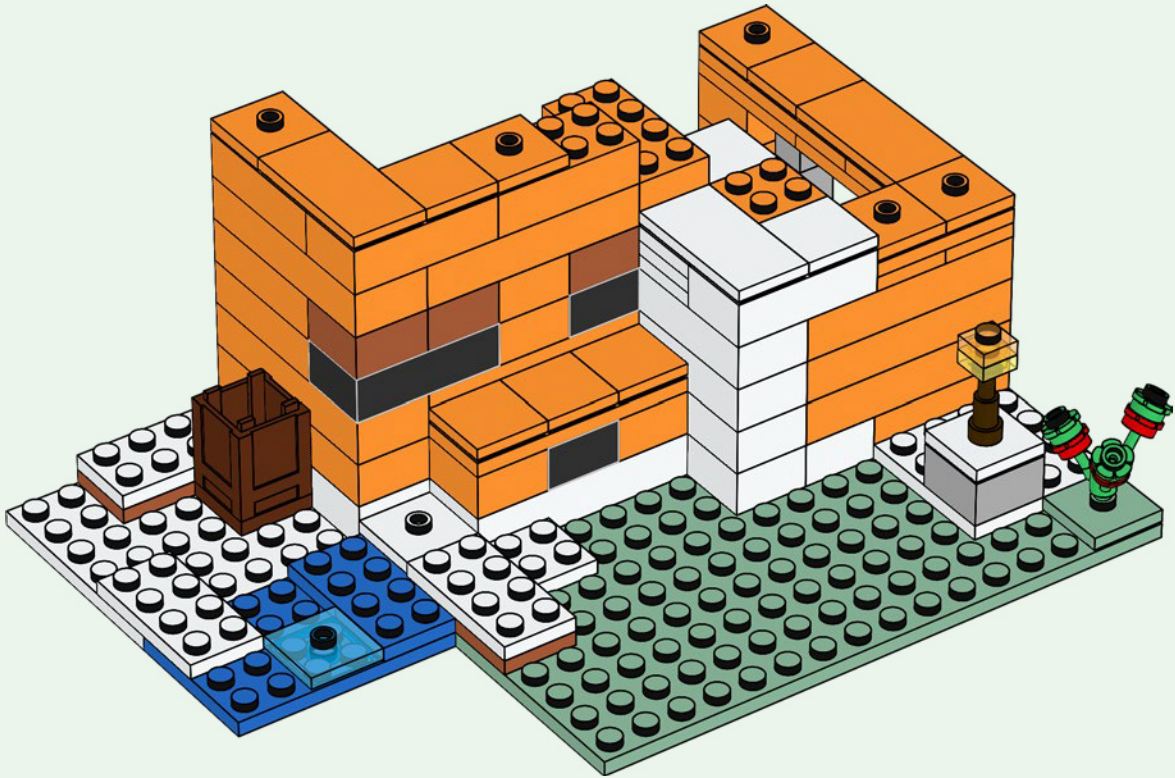

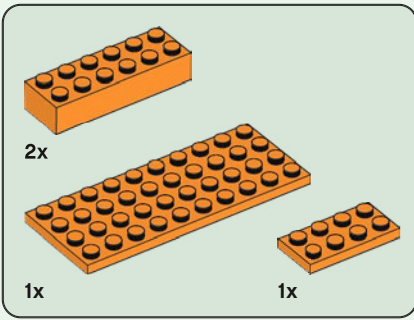

37

1

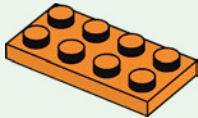

2

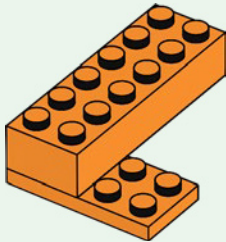

3

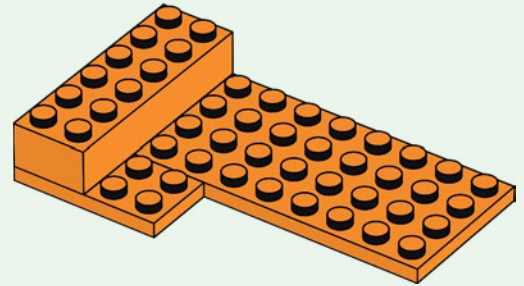

4

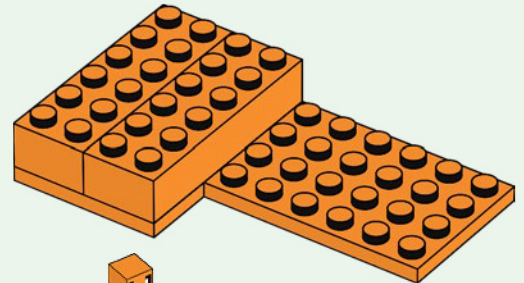

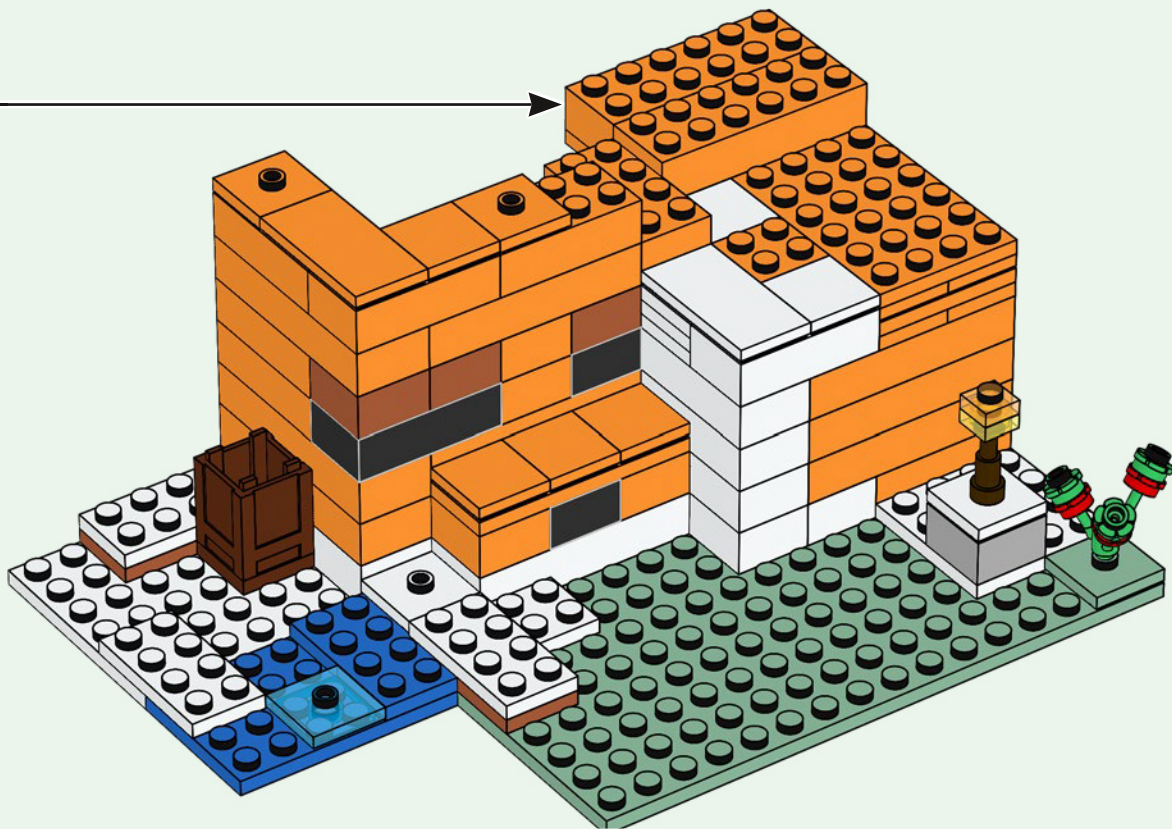

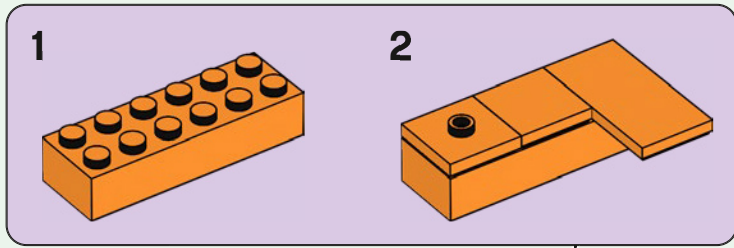
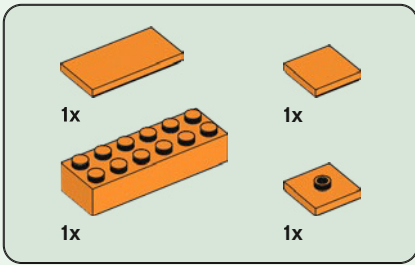

38

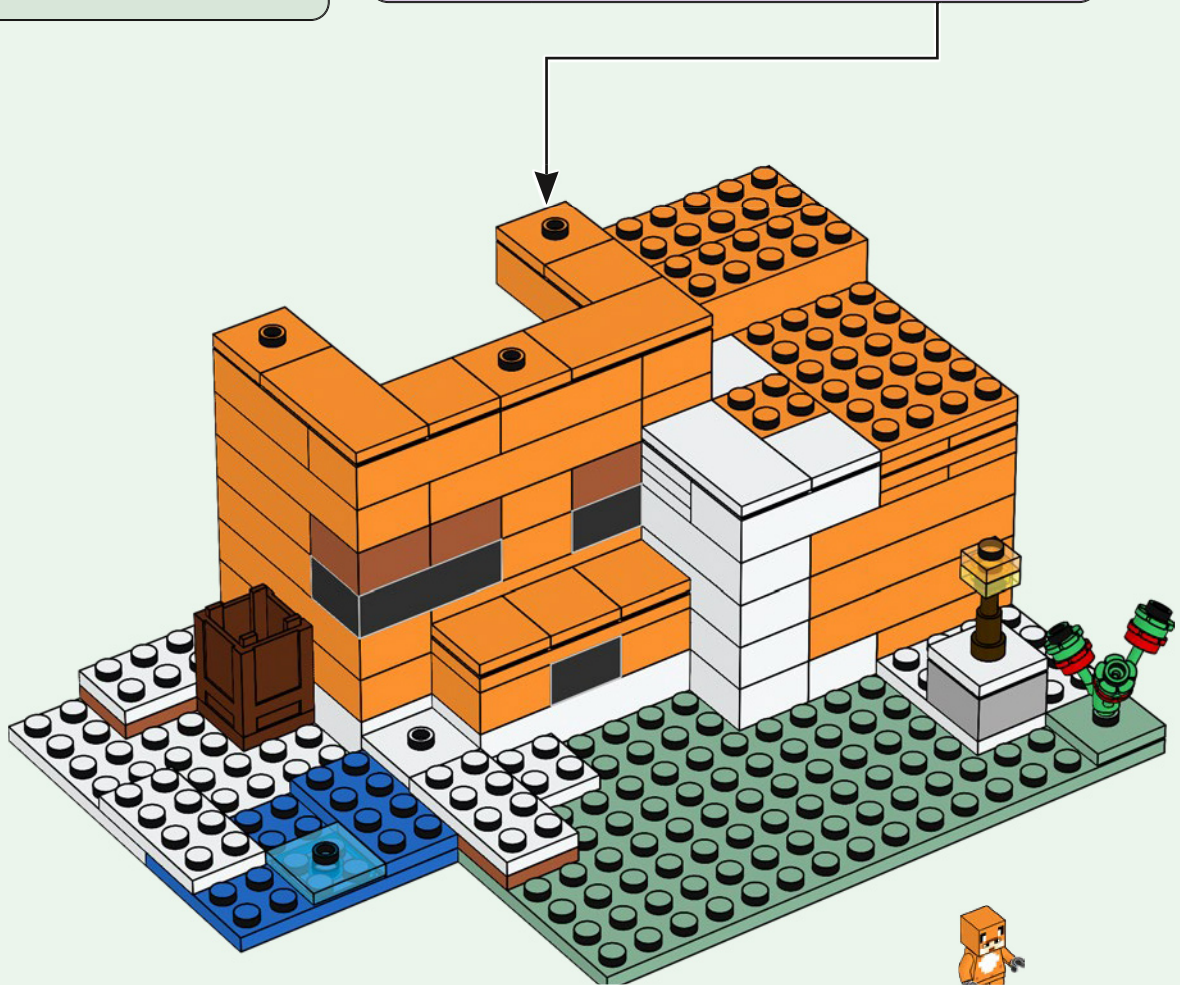

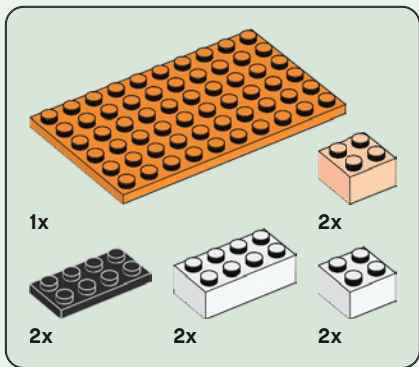

39

1

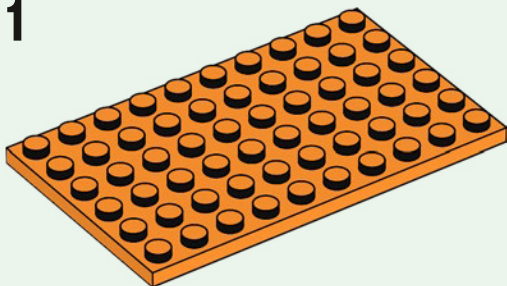

2

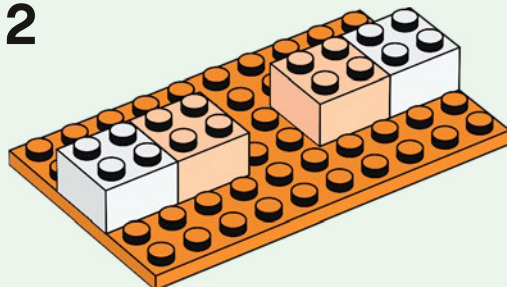

3

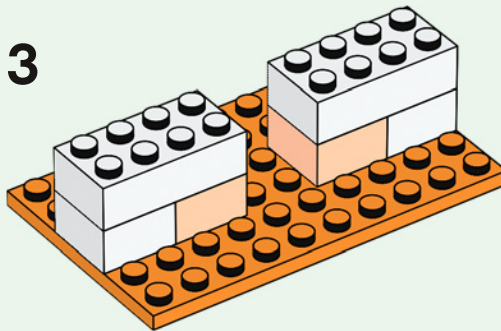

4

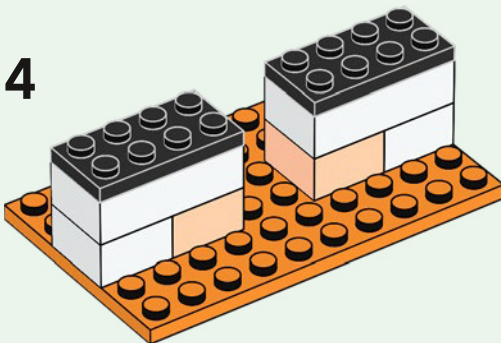

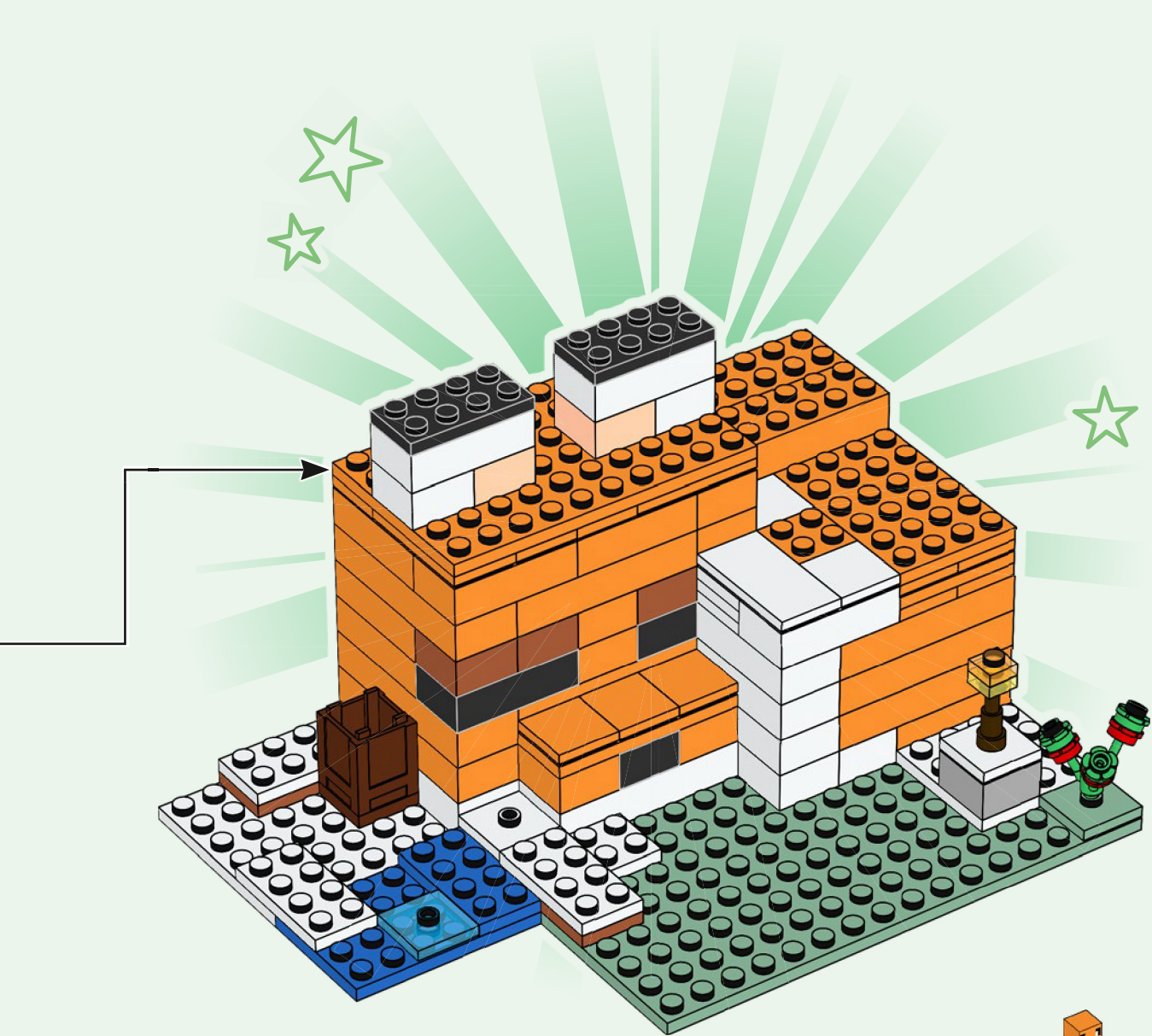

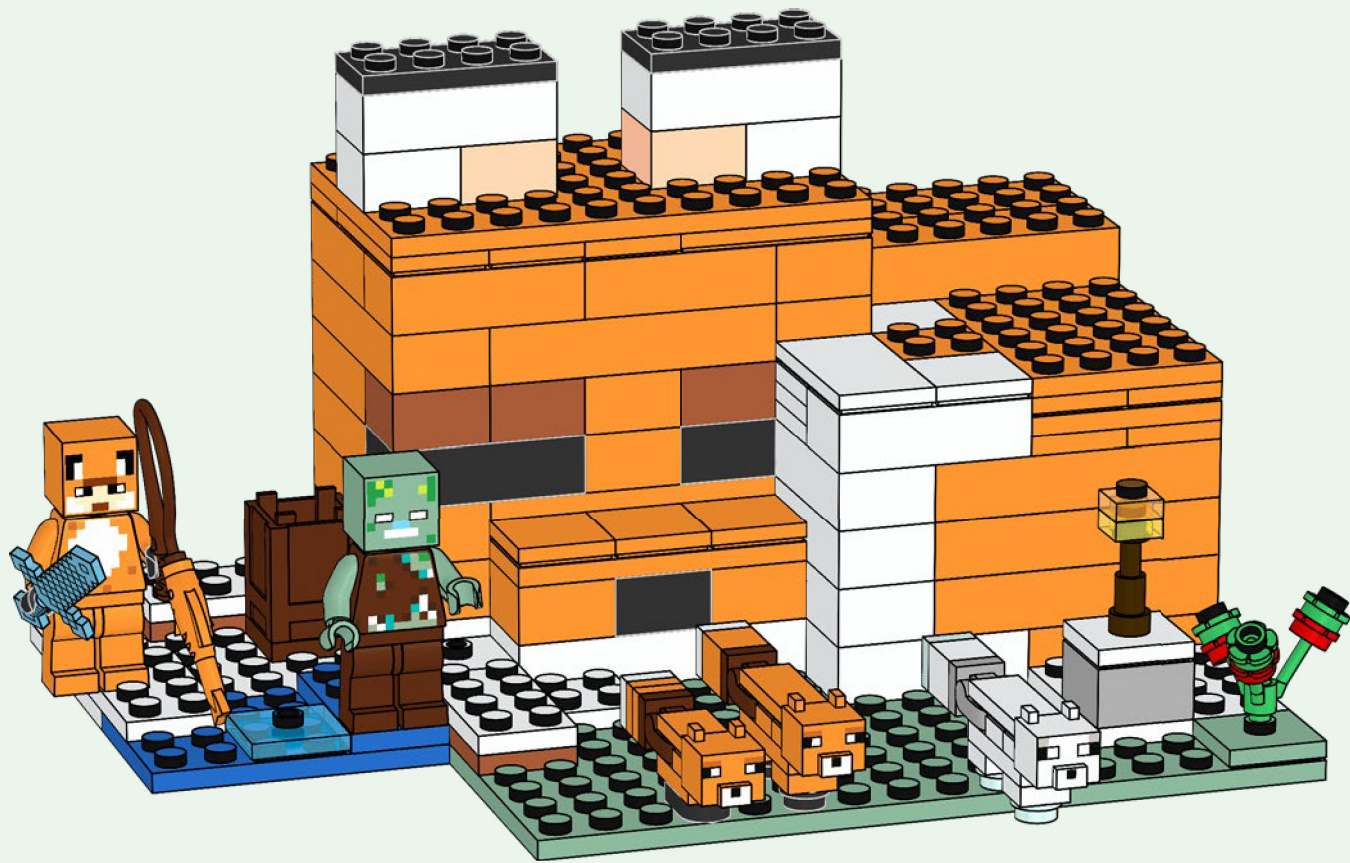

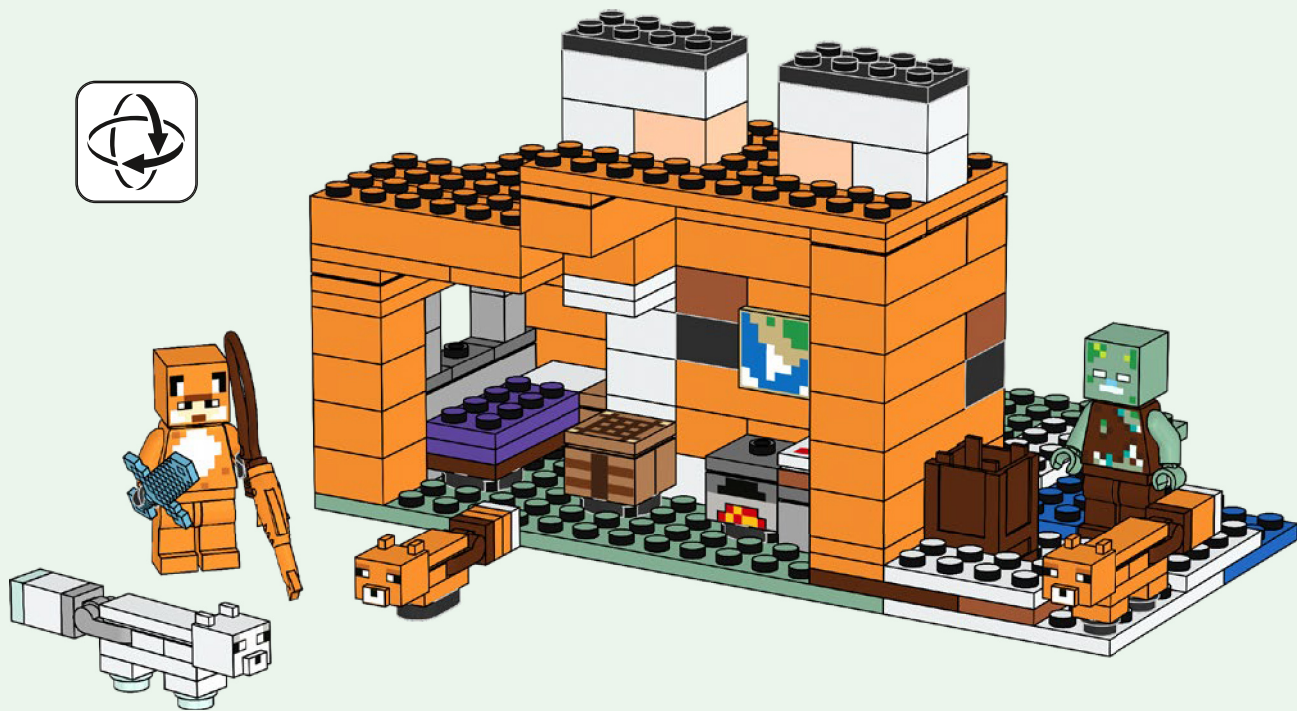



1x
6252040



2x
6348057



1x
6359864



2x
6153863



1x
4520638



1x
6336857



1x
4221886



1x
4243838



1x
4211247



2x
614126



1x
6210270

54



1x
6308012



4x
4211389



1x
6225246



2x
4211387

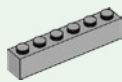

1x
4211393



1x
4211452



1x
6216860



3x
6092572



1x
6216862



5x
6126083



2x
6030277



1x
4538950



2x
6097024



1x
6102994



1x
6097003



1x
6058085



1x
6382577



3x
4615606



3x
6212081



4x
403226



2x
300326



2x
302026



1x
300126



5x
302401



1x
300501



1x
6383982



1x
6385113



1x
6296995



3x
306801



3x
302201



2x
6126046



3x
300301



1x
362301



5x
300101



2x
4243812



1x
379501



5x
4181142



1x
4144012



1x
4558168



4x
302001



1x
4560178



1x
6269971



1x
6385114



1x
6093623



2x
6382504



1x
6058016



1x
4243815

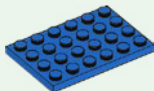

1x
303223



1x
6382531



1x
6252045



5x
4524929



3x
6206148



5x
4158355



3x
4648853



9x
4153827



3x
4121741

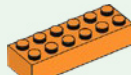

11x
6382506

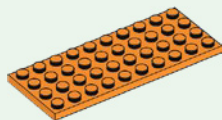

1x
6382505

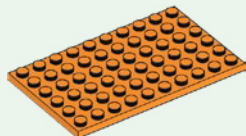

1x
6034497



1x
4121739



1x
4177932



1x
4188771



2x
6293300



3x
4159007



6x
6126063



6x
4542142



1x
4173805



1x
6385115



6x
4153825



1x
4623481



1x
6147047



1x
4620693



1x
6389950



1x
4120158



1x
6186826



1x
6335312



5x
6135287



2x
6297283

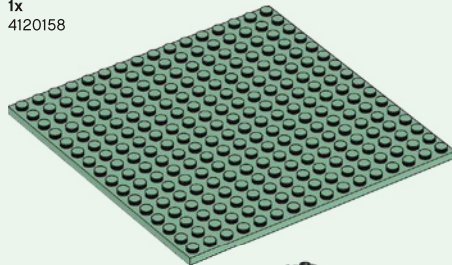

1x
6382507



[LEGO.com/service](https://www.LEGO.com/service)

YOU COULD **WIN**



Scan this QR code or go to **LEGO.COM/PRODUCTFEEDBACK** and give us your short feedback about this LEGO® set for a chance to win a cool LEGO prize.

Terms and Conditions apply*

EN: YOU COULD WIN. Terms and Conditions apply* **DE: Du könntest GEWINNEN.** Es gelten die Teilnahmebedingungen* **FR: Tu pourrais GAGNER.** Des conditions s'appliquent* **IT: Potresti VINCERE tu.** Termini e condizioni sono applicabili* **ES: Puedes GANAR.** Aplican términos y condiciones* **PT: Poderá GANHAR.** Aplicam-se termos e condições* **ZH: 轻松获奖. 条款和条件适用*** **PL: Szansa na WYGRANĄ.** Obowiązują warunki korzystania* **CS: Máte šanci VYHRÁT.** Platí všeobecné smluvní podmínky* **SK: Máte šancu VYHRAŤ.** Platia všeobecné zmluvné podmienky* **HU: TE IS NYERHETSZ.** Felhasználási feltételek érvényesek* **RO: Ai putea CÂȘTIGA.** Se aplică termeni și condiții* **BG: Можете да СПЕЧЕЛИТЕ.** Има определени правила и условия* **LV: Tu vari LAIMĒT.** Ir spēkā noteikumi un nosacījumi.* **ET: Sul on võimalus VÕITA.** Kehtivad tingimused* **LT: Jūs galite LAIMĖTI.** Taikomos sąlygos*

*[LEGO.com/productfeedback-terms](https://www.lego.com/productfeedback-terms)